

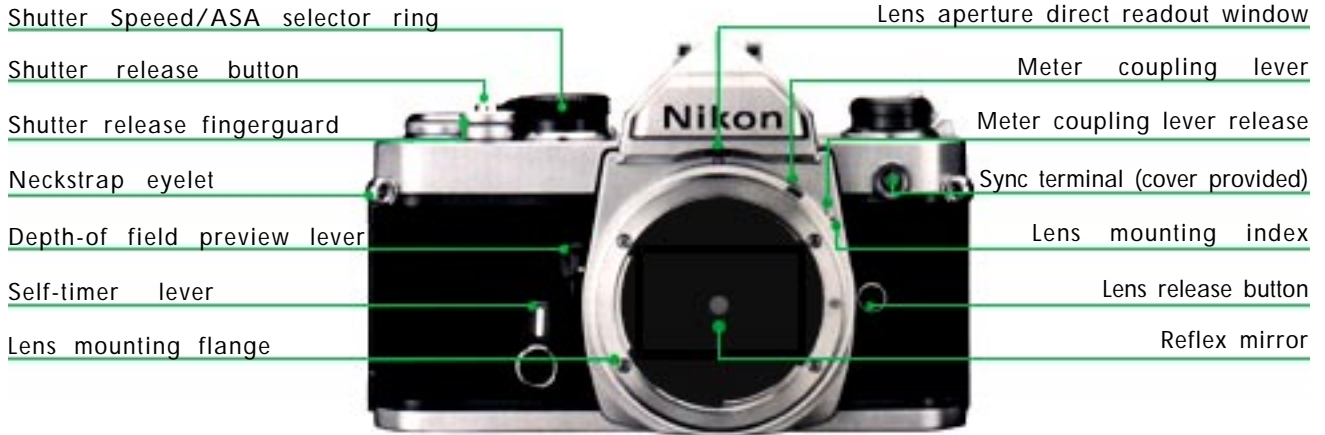

**INSTRUCTION MANUAL**

# NOMENCLATURE



Focusing distance scale

Aperture/distance scale index

Focusing ring

Meter coupling shoe

Aperture ring

Depth-of-field indicators

Meter coupling ridge

Aperture-direct-read out scale



Film rewind crank

Shutter speed selector

Film rewind knob

Frame counter

Safety lock

ASA film speed window

Film plane indicator

Meter ON index

Hot-sync shoe

Film-advance lever

Hot-shoe contact

ASA film speed index

Viewfinder eyepiece

Multi-exposure button

Shutter speed index

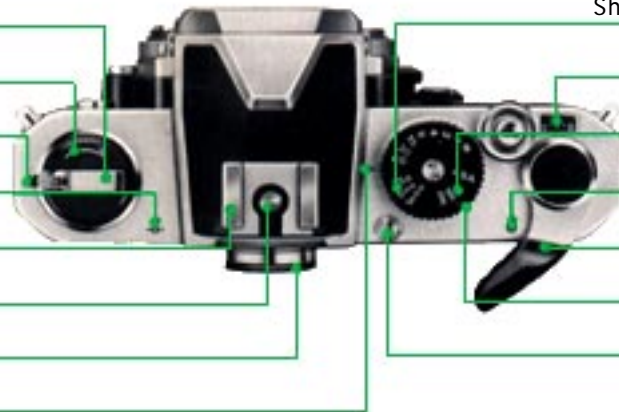

# CONTENTS

Foreword.....	5	Focusing.....	16
Preparation for use.....	6	Infrared photography.....	18
Installing the batteries . . . . .	6	Film-planeindicator.....	18
Checking battery power.....	6	Depth of field.....	19
Loading film.....	7	Depth-of-field preview lever.....	19
Prior to shooting.....	8	Depth-of-field indicators.....	20
Memo holder.....	9	Exposure measurement.....	22
Setting the film speed.....	9	Determining degree of exposure.....	22
Operation of camera controls.....	10	Exposure control.....	24
Setting the shutter speed.....	10	Metering range . . . . .	24
Setting the aperture.....	10	High-contrast lighting.....	25
Film-advance lever.....	11	Stop-down exposure measurement.....	26
Frame counter.....	11	Exposure compensation adjustment.....	27
Self-timer.....	12	Multiple exposures.....	28
Unloading film.....	13	Flash synchronization . . . . .	29
Holding the camera.....	14	Tips on camera care.....	30
Shutter release operation.....	15	Mounting and removing lenses . . . . .	31
Operation by cable release.....	15	Accessories. . . . .	32
		Features/Specifications.. . . . .	34

## FOREWORD

The Nikon FM is a compact 35mm single-lens reflex camera that offers a host of advanced features amateur photographers and professionals alike will appreciate. It is designed to accept virtually every accessory of the Nikon System—the most comprehensive ever created for photography—so it can do virtually everything the top rated SLR's can do . . . with that unique precision and reliability which you have come to associate with Nikon. To get the most out of this camera, study the instructions in this manual carefully, as well as those in related manuals, and practice using the controls—before loading the camera with film. Keep the manual on hand for ready reference until you have mastered operation. The few minutes you spend familiarizing yourself with the camera will guarantee you the best results and increase your pleasure in taking pictures many times over.

## PREPARATION FOR USE

### Installing the Batteries

The Nikon FM's built-in exposure meter is powered by two button-cell type 1.5V silver-oxide batteries. These are mounted in the battery clip, which forms a single unit with the battery chamber's coin-slotted lid, in the camera's baseplate. To install the batteries, first unscrew the lid by turning it counterclockwise, with a coin or something similar, until it can be freely removed by hand. Then, seat the two batteries in the battery clip, one on top of the other, making sure that their respective plus (+) and minus (-) indications correspond with similar marks provided in the clip. After seating the batteries correctly, replace the lid, and secure the connection by turning it clockwise with the coin as far as it will go. It is advisable to remove the batteries, when the camera is not to be used for a long period, to prevent battery leakage within the camera; for additional information on this, refer to "Tips on Camera Care" on page



### Checking Battery Power

To check battery power, move the camera's film advance lever from the flush to the stand off position by pulling it just far enough to uncover the red index on top of the camera. Then, look through the viewfinder. If any of the LED (light emitting diode) exposure indicators is on, battery power is sufficient for proper operation. Otherwise, check battery seating and make adjustments, if necessary. Should the LED display still fail to light up, change batteries.

Important: When the camera is not in use, make sure that the film advance lever is positioned flush with the camera body. As the lever doubles as the meter on/off switch, leaving it in the stand-off position will result in the camera's battery being completely drained in just a few days.



## Loading Film

First, open the camera back by sliding its safety lock to the rear and lifting the film rewind knob as far as it will go. Position the film cartridge or cassette in the film chamber, which is located on the left-hand side, with the film leader aligned along the film guide rails; then, push the rewind knob to hold the cartridge in place. Pull the film leader out sufficiently for feeding into the film take-up spool, and insert its end into any of the spool's slots. Rotate the take-up spool as shown in the illustration so that the film passes under the spool with its emulsion

side (dull side) facing out. Make sure that the perforations along the edges of the film mesh with the sprockets. If necessary, release the shutter by cocking the shutter release button, and stroke the film advance lever slowly to make sure that the leader winds smoothly on the spool and that the film edge perforations engage the film sprocket roller. When you are certain that the film is being fed properly onto the spool and traveling correctly along the film guide rails, close the camera back by pressing it until it snaps into place.

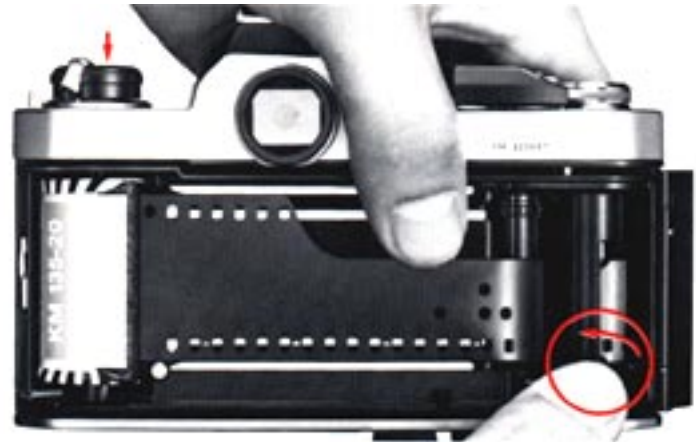

## PREPARATION FOR USE - continued

### Prior to Shooting

Fold out the film rewind crank, and turn it gently in the direction of the engraved arrow until you feel a slight resistance; this will indicate that any slack in the film cartridge has been taken up. Then, fold the rewind crank into place.

Advance the film (refer to page 11 for film advance operation), and make two blank exposures; this will dispose of the initial portion of the film exposed during loading. As you

advance the film, confirm that the rewind crank turns in the direction opposite the arrow. This indicates that the film has been loaded properly and is being advanced.

After advancing the film two frames, check that the frame counter is at "0"; then, advance the film one more frame to prepare the camera for taking the first picture.





## Memo Holder

A special holder is provided on the camera back for convenient storage of any relevant information. You can use it, for instance, to hold the end flap of a film carton to remind you of the type of film loaded in the camera, the ASA film speed and the total number of exposures available.



## Setting the Film Speed

The camera's exposure meter must be adjusted to the speed of the film in use to ensure correct measurement. Accordingly, the camera is provided with an ASA film speed scale. To make the necessary adjustment, lift the knurled ASA film speed ring, and turn it until the triangular red index is aligned with the ASA value of the film loaded in the camera. The meter is sensitive across the full range of from ASA 12 to ASA 3200; there are two dots between each number for intermediate ASA settings, i.e., 64, 80, 125, etc.

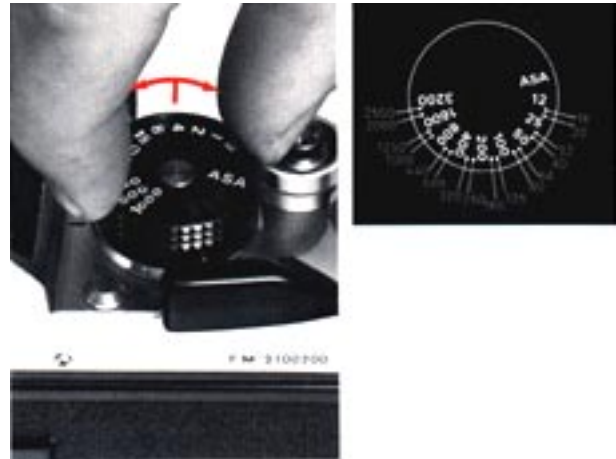

## OPERATION OF CAMERA CONTROLS

### Setting the Shutter Speed

The Nikon FM's shutter speed selector is knurled for slip-free, easier manipulation; the face of the dial is engraved with the 11 shutter speed settings available: 1 for one second, and 2, 4, 8, 15, 30, 60, 125, 250, 500 and 1000 for fractional values of from 1/2 to 1/1000th of a second. A "B" setting, also engraved, is provided for longer time exposures. To set the shutter speed, turn the shutter speed selector until the desired speed is aligned with the shutter speed index. The speed selected (including "B") is shown on the left-hand side of the viewfinder, too, for instant reference.

Note that the 125 setting is engraved in red; this indicates 1/125 sec., the fastest shutter speed available for flash synchronization with electronic flash units. (Refer to page 29 for additional information on flash photography.) Also, at



the "B" setting, the shutter remains open for as long as the shutter release button is kept depressed.

### Setting the Aperture

The Nikon FM works best with Nikkor lenses. The aperture rings of these lenses are knurled for slip-free, easier manipulation.

To set the lens aperture, turn the lens aperture ring until the desired f/number setting on the lens aperture scale is aligned with the index mark on the lens; intermediate settings are also usable, when required.

Note that, with Nikkor lenses provided with an aperture direct-readout (ADR) secondary lens aperture scale, the f/number selected appears on the upper portion of the viewfinder for convenient reference when shooting.



## Film-Advance Lever

The film-advance lever simultaneously advances the film, cocks the shutter and operates the frame counter. It also doubles as the Nikon FM's meter on/off switch and shutter button lock.

To advance the film, stroke the lever with your right thumb as far as it will go. The film will be advanced a full frame. The lever automatically returns to its 30° stand-off position when released upon the completion of the film advance.

The film-advance lever switches the meter on when moved to its stand-off position; it switches the meter off when moved back flush with the camera body. With the lever set flush against the camera body, it serves also as a lock to prevent accidental tripping when the shutter is cocked.



## Frame Counter

Each time the film is advanced one frame by a full stroke of the film advance lever, the frame counter operates to show how many frames have been exposed. It is automatically reset to S (start), two frames before 0, when the camera back is opened to remove an exposed film cartridge and/or load a new roll of film. The frame counter dial has indications for up to a maximum of 36 frames, with all odd numbers calibrated in dots and all even numbers in figures. The figures are in white, except for 12, 20 and 36 which appear in red to indicate the maximum number of exposures available, respectively, with standard film cartridges.

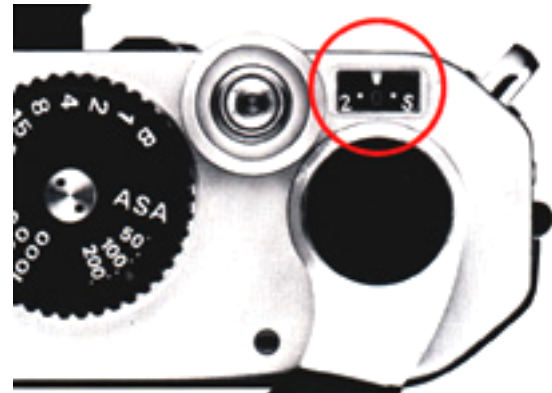

## OPERATION OF CAMERA CONTROLS - continued

### Self-Timer

The built-in self-timer provides an approximately 8 to 14 second delay between the time the shutter release button is depressed and the time the shutter is actually fired. It can be used with any of the marked shutter speeds between 1/1000 and 1 sec. Avoid using the selftimer with the shutter speed dial set to "B" as, on this setting, the shutter will only open momentarily and incorrect exposure will invariably result. To take a picture using the self-timer, first set the aperture

and shutter speed controls, advance the film, and cock the self-timer by turning the self-timer lever downwards. Then, depress the shutter release button and the timer will start. A unique feature of the FM's self-timer lever is that its setting is "cancellable." In other words, should you decide not to use the self-timer after setting it, you simply turn it back upwards and resume normal shutter tripping operation. For critical close-up photography, the self-timer, in combination with a tripod, is particularly useful in preventing vibration.



## UNLOADING FILM

As soon as the frame counter indicates that the last exposure has been made, or when the film advance lever can no longer be stroked, the roll of film has been fully exposed and can now be removed.

To unload the roll of film, first press the rewind button on the camera's baseplate; then, unfold the film rewind crank and turn it in the direction of the engraved arrow with smooth, even pressure. Rewind tension will cease to indicate that the film leader has left the take-up spool. Now, open the camera back by sliding its safety lock and pulling up the rewind knob

as far as it will go; then, remove the film cartridge. Note that when the film advance lever is stroked for the next exposure (with the next roll of film), the rewind button will be released to engage the filmadvance mechanism once again.

You should not push the rewind button during film advance operation; otherwise, film advance will temporarily stop and frame-overlap may result. Note, too, that the camera back can be removed from the body by depressing the locking catch on the hinge.



## HOLDING THE CAMERA

Camera shake is one of the most common causes of blurred, unsharp pictures, especially at slow shutter speeds. To prevent this, study how to hold the camera correctly and practice steady shutter squeezing.

Wrap the fingers of the right hand around the camera body so that the index finger of your right hand rests comfortably on the shutter release button and the thumb fits between the camera body and the film advance lever. Position the camera in such a way that the eye looks through the center of the viewfinder. Cradle the camera with your left hand for additional support, using the thumb and middle finger to grasp the focusing ring. This way, the camera is properly supported and can easily be switched from horizontal to vertical shooting.



## SHUTTER RELEASE OPERATION

Correct shutter release operation is just as important in obtaining sharp pictures as holding the camera properly. To release the shutter correctly, move the advance lever to its stand-off position, hold the camera steadily and depress the shutter release button with smooth, even pressure. Relax even when you're in a hurry—a quick jab at the shutter release button will cause camera shake and result in an unintentionally blurred photograph.

### Operation by Cable Release

The shutter release button can also be tripped with the use of

a cable release (or some similar accessory). To attach the cable release to the camera, screw the threaded cable connector onto the mount provided with the button. The shutter is then tripped by depressing the cable release plunger. Cable release operation is especially recommended for critical shooting situations, such as photomicrography or time exposure, where vibrationfree shutter release is of prime importance.

Important:: If you mount the Nikon FM on a tripod with a large head, contact between the lens body and the head may make it impossible to turn the lens aperture ring. If this happens, use the special tripod adapter (supplied with the camera) between the tripod head and camera body.



## FOCUSING

When the FM is used with a Nikkor lens fitted with an automatic diaphragm, focusing is done at full aperture. This makes for the brightest possible images on the focusing screen, enabling easy focusing and composing. The focusing screen itself gives you a choice of three focusing aids: a central split-image rangefinder spot, an annular microprism grid and a fine matte outfield.

To focus, using the split-image rangefinder spot, turn the focusing ring of the lens until the two halves of the rangefinder spot perfectly coincide, forming a single, crisp image. To focus with the microprism grid, turn the focusing ring until the image seen through the microprism pattern appears sharp

and crisp. With the matte outfield, turn the ring until the image viewed in the field appears sharp.

The split-image rangefinder spot is considered the most suitable for precise, pinpoint focusing, and the microprism grid for rapid focusing in sports or action-type photography. The fine matte outfield, on the other hand, is ideal for use with telephoto lenses or in close-up and macrophotography.

You can also prefocus the lens with the use of the distance scale engraved in both meters and feet on the lens barrel. Simply turn the focusing ring until the measured or estimated camera-to-subject distance is lined up with the distance scale index on the lens barrel. This technique is useful for picture-taking situations where either the subject is elusive or time does not permit through-the-lens focusing.





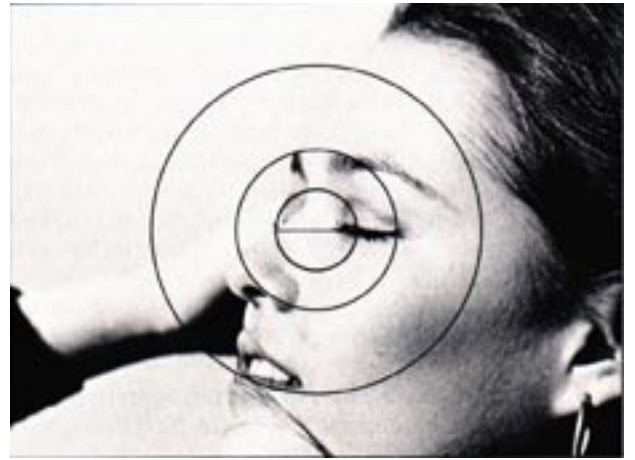
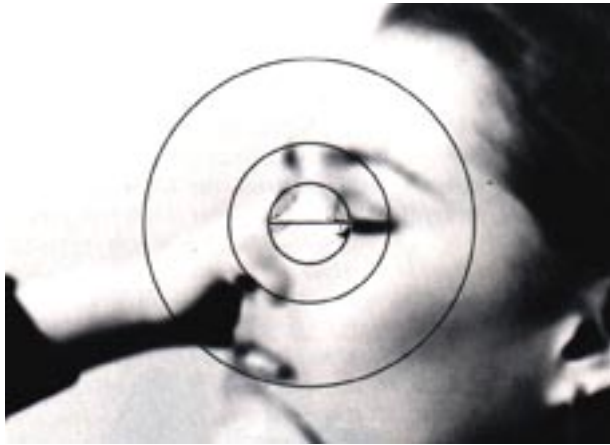

## FOCUSING - continued

### Infrared Photography

The plane of sharpest focus for infrared light is slightly farther away than its counterpart for visible light as seen through the camera's viewfinder. To compensate for this, first focus the image sharply through the viewfinder. Then, turn the focusing ring counterclockwise until the point focused is aligned with the red dot (or line) provided on the lens barrel. For example, in the picture below, the lens has been focused for infinity (∞) infrared shooting. Note that when lenses with a focal length of 50mm or less are used stopped-down to f/8 or below, compensation is not necessary due to the large depth of field available.

There are some Nikkor lenses that do not require refocusing for infrared photography; refer to their instruction manuals for details.



### Film-Plane Indicator

To ensure the best results in critical picture-taking situations, such as close-up or copy photography, it is necessary to determine the exact subject-to-film-plane distance. The Nikon FM is thus provided with a film plane indicator ( - - ); this is positioned exactly in the film plane, which is 46.5mm from the front surface of the lens mounting flange.

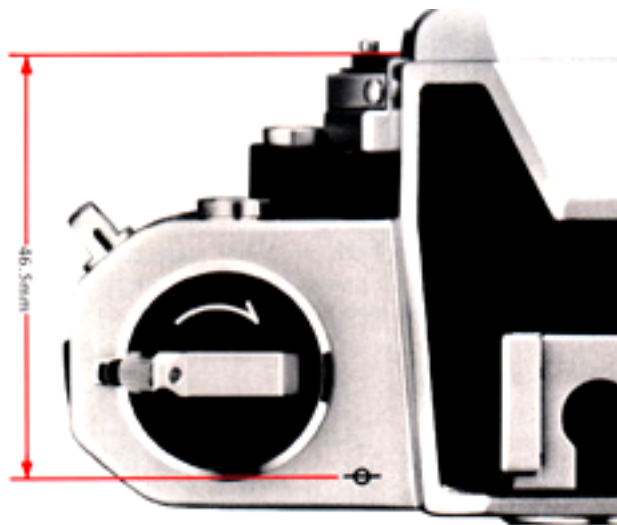

## DEPTH OF FIELD

When you focus on your subject, you will find that not only is the subject itself in focus but that objects both in front of and behind it appear to be in focus. This “zone” of focus is called “depth of field.”

Depth of field is not a fixed quantity. It varies by lens, depending on both the subject’s distance from the camera and the specific lens aperture in use. A third factor, the focal length of the lens, also influences the apparent depth of field, i.e., the longer the lens, the shallower the depth of field appears to be, and vice versa. In the same manner, the wider the taking aperture (i.e., the lower the  $f$ /stop number), the shallower the depth of field, and vice versa. Also, the closer you approach your subject, the shallower the depth of field becomes, and vice versa. In all cases, you will find that the depth of field behind the subject is larger than that in front; this enables selective blurring of the background elements of the picture, a technique most often used by the creative photographer.

### Depth-of-Field Preview Lever

Most of the Nikkor lenses you will find yourself using with the Nikon FM are “automatic.” This means that the aperture diaphragm of the lens is kept open at its widest setting while you are viewing, focusing and metering. When you press the shutter release button, the camera’s mechanism automatically

“stops down” (i.e., closes the lens aperture) the lens to the aperture at which it is set.

To examine the depth of field before taking a picture, it is necessary to stop down the lens manually. You can do this by exerting slight finger pressure on the FM’s conveniently situated depth-of-field preview lever. Assuming that the lens is set to an aperture other than its maximum, gentle pressure on the lever will stop down the lens to that aperture. You will then be able to see the elements in front of and behind the main subject that will appear in sharp focus in the actual photograph— although some of them may have appeared not to be in focus prior to pressing the lever. A side effect of this picture-taking process is the “darkening” of the image in the viewfinder (the higher the  $f$ /number, the “darker” the image appears); this is normal and should be no cause for concern.



## DEPTH OF FIELD - continued

### Depth-of-Field Indicators

The Nikkor lens' depth-of-field indicators come in the form of the three scales fitted on the lens barrel. The first is the lens aperture scale, with the  $f$ /numbers colorcoded. The second consists of two sets of colored lines, the colors corresponding to the colors of the  $f$ /numbers. The third is the focusing scale which is calibrated in meters and feet.

To determine depth of field, note the color of the  $f$ / number in use. The depth of field at the taking aperture is indicated by the numbers on the focusing scale which are adjacent to the colored lines that correspond to the color of the  $f$ /number set.

Example

Taking aperture:  $f/16$  Color: Blue

Focusing distance: 5m

In the example above, the farthest point of sharp focus behind the subject is infinity ( $\infty$ ); this is the figure on the focusing scale which is adjacent to the blue line on the second scale, which in turn corresponds to the blue color of the  $f/16$  setting. The closest point of sharp focus is 2.7m, although this number does not appear in the focusing scale.

Note that for exact depth-of-field determination, you should refer to the depth-of-field tables in the instruction manual for the Nikkor lens in use.



Lens set at  $f/4$ : Shallow depth of field centered on the main subject.





Lens at  $f/8$ : Depth of field extended in front of/behind the main subject.



Lens at  $f/16$ : Sharp focus is extended to encompass the entire foreground and background



## EXPOSURE MEASUREMENT

The Nikon FM's built-in exposure meter utilizes Nikon's proven center-weighted through-the-lens metering system which is cross-coupled with both the shutter speed control of the camera and the aperture control of the lens mounted on the camera. The meter reads the intensity of the light coming through the lens over the entire focusing screen at full aperture but favors the central 12mm-diameter area outlined on the screen—allowing you to make precise readings and making for overall balanced exposures.

+ 0 -	Overexposure by more than 1 stop
+ 0 -	Overexposure by 1/5 to 1 stop
+ 0 -	Correct exposure
+ 0 -	Underexposure by 1/5 to 1 stop
+ 0 -	Underexposure by more than 1 stop

### Determining Degree of Exposure

The viewfinder has three exposure indicators visible within the viewfield: + for overexposure, o for correct exposure and — for underexposure. These indicators have corresponding LED's which light up when the film advance lever is moved to its 30° stand-off position; as you can see in the chart on the left, there are five combinations possible. Also included inside the viewfinder as aids to exposure determination are the shutter speed selected and the lens aperture setting. With non-AI type lenses, the lens aperture is not visible. To determine correct exposure, first switch the meter on by moving the film advance lever to its stand-off position. One or two of the LED's will light up opposite the corresponding exposure indicator/s to show you the precise degree of exposure. If the + indicator LED lights up, increase the shutter speed or decrease the aperture—or vice versa—until the o indicator LED lights up and the + indicator LED turns off; the procedure is the same if the—indicator LED lights up alone or with the Vindicator LED.

It is normally impossible for all three LED's to light up at the same time, or for the + indicator LED and—indicator LED to light up simultaneously. The exception to this is when photographing a television screen. The rapidly scanning spot pattern that produces the TV picture results in a cyclic effect that causes all three LED's to light up when the exposure setting is correct.



## EXPOSURE MEASUREMENT - continued

### Exposure Control

The amount of light reaching the film plane is determined by a combination of the shutter speed and the lens aperture. Since the two are interrelated, different combinations will give the same degree of exposure. A 1-step change in shutter speed, or a 1-stop change in aperture setting, will either halve or double the degree of exposure. For example, a shutter speed of 1/125 sec. lets in twice as much light as a setting of 1/250 sec., and only half as much light at a speed of 1/60 sec.; for an aperture setting of f/11, twice as much light as f/16, and half as much as f/8, is let in. Thus, if the correct exposure for a particular picture-taking situation is 1/125 at f/11, then 1/60 at f/16 or 1/250 at f/8 will be equally acceptable. The following table illustrates the interrelationship between shutter speed and aperture we have just described.

Shutter speed (second)	1/1000	1/500	1/250	1/25	1/60
Aperture	f/4	f/5.6	f/8	f/11	f/16

The “best” combination will depend on the results you want. Use fast shutter speeds to “freeze” motion; use slow speeds to produce a deliberate blur. Also, small apertures give greater depth of field, while large apertures restrict sharp focus to the main subject. Make your choice accordingly.

### Metering Range

If the central exposure indicator LED (Io) fails to light up, even after all possible lens aperture and shutter speed combinations have been tried, then the available light is either too bright or too dim for the meter’s range. In this case, you can either use artificial light (such as an electronic flash unit) to increase subject illumination or mount a neutral density filter on the lens to decrease the amount of light reaching the film.

Remember, too, that the lens in use is an equally important factor to consider. For example, a 50mm f/1.4 lens (with ASA 100 film) couples from EV 1 (f/1.4 at 1 sec.) to EV 18 (f/16 at 1/1000 sec.), making it suitable for low-lightlevel picture-taking situations; on the other hand, a 135mm f/2.8 lens proves more suitable for bright-light shooting, coupling (with ASA 100 film) from EV 3 (f/2.8 at 1 sec.) to EV 20 (f/32 at 1/1000). Thus, choose the lens carefully to match the existing lighting conditions.



## High-Contrast Lighting

When there is a substantial difference in brightness between the main subject and the background, seemingly unimportant bright spots or dark spots can adversely influence the finder reading and thus affect the actual exposure.

To compensate for an excessively bright (or dark) background, target the main subject in the center of the focusing screen, then perform metering (i.e., determine the degree of exposure you want) by making the necessary shutter speed and/or lens aperture adjustments.



• Metering with a bright area in the center will cause underexposure of the main subject.

After completing this procedure, make your final picture composition and shoot without readjusting either shutter speed or lens aperture. When shooting landscapes, for example, it is often advisable to aim your camera slightly downwards while metering to eliminate the effects of bright expanse (i.e., the sky); without such compensation, the landscape may appear underexposed in the final print. Also, for backlit subjects, it may be necessary to move closer to ensure proper exposure measurement.

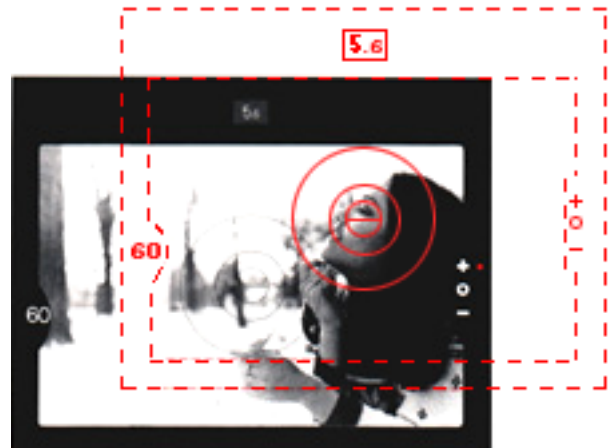

• For correct exposure, first measure the main subject then, recompose and shoot.

## STOP-DOWN EXPOSURE MEASUREMENT

The vast selection of lenses available for use with your Nikon FM includes some which are fitted neither with an automatic diaphragm nor a meter coupling ridge, both of which are essential to full-aperture exposure measurement. The FM works even with such lenses, through an alternative method called “stop-down” exposure measurement. Note that when this type of lens is used with the camera, the meter coupling lever should be raised and locked up out of way manually by depressing and holding the coupling lever release button; to avoid accidental damage, make sure you do not use excessive force when raising up the lever.

This is how stop-down exposure measurement is performed. After you’ve composed your picture, move the film advance lever to its stand-off position and press the camera’s depth-of-field preview lever. Keep the lever pressed, and adjust either the shutter speed dial or the lens aperture ring (or both)—until the correct exposure indicator (a) LED lights up. Then, release the lever and shoot.

It is advisable, at all times, to refer to the instruction manual of the lens in use—especially if it is a fixed aperture lens (e.g., Reflex-Nikkor) or one requiring a focusing unit (e.g., Nikkor 1200mm f/11)—when performing stop-down exposure measurement. The same applies when bellows units, extension rings, preset lens (e.g., PC-Nikkor), etc. are used with the FM.

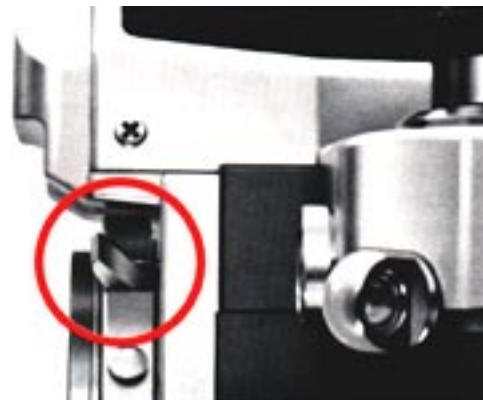

## EXPOSURE COMPENSATION ADJUSTMENT

“Correct exposure” is not an absolute value. It depends on the characteristics of the metering system, the film in use and the subject. Thus, all film and camera manufacturers calibrate their meters, using the correct rendition of skin tones as the standard or most representative of the vast majority of shooting subjects.

For some specialized subject-and-film combinations, however, these meter calibrations require some compensation to be made in order to ensure correct exposure. The following table lists the corrections required for these combinations. Note that the corrections are listed in terms of exposure value, or EV. A change of +1 EV, for instance, can be achieved by moving the lens aperture ring by one stop, or the shutter speed dial by one shutter speed indication (i.e., a change from f/2 to f/2.8 represents a change of +1 EV, and a change of shutter speeds from 1/60 to 1/30 represents a change of —1 EV).

For very specialized application, consult both the instruction manual of the accessory in use and the technical literature provided by the film manufacturer. Also, you will find the special 18% reflective gray card available from Nikon and major film companies especially useful for copying and general studio work.

Original Type of film	Repro-copying & slide-copying			Photo- micro- graphy
	B&W color photo	Letters or figures on light background	Letters or figures on dark background	
Panchromatic film for general use	No compensa- tion necessary	+1 1/2 stops	- 1/2 stop	+1 stop

## MULTIPLE PURPOSE

Intentional multiple exposure (two or more exposures on the same frame) for creative effects are easy with the FM. First, make the initial exposure. Then, slide the multi-exposure button as far as it will go, and hold it while you stroke the film-advance lever; repeat this procedure for each additional exposure on the same frame. When you have achieved the desired number of exposures on the same frame, release the button and stroke the film advance lever once more. Note that during multiple exposure operation, both the camera's shutter speed and the lens aperture can be freely changed to any setting; also, the frame counter will remain at the same setting until the multi-exposure button is released—a convenient way of confirming that multiple exposure operation is proceeding properly.



## FLASH SYNCHRONIZATION

Flash photography with the FM is easy. The camera is designed to synchronize with electronic flash at speeds up to 1/125 sec. You can use its hot-sync shoe to mount any ISO-type electronic flash unit or speedlight directly onto the camera. For off-camera flash photography, or when using a non-ISO-type speedlight, you will need a sync cord to connect the unit to the camera's threaded sync terminal.

Flash-bulb	Shutter speed (sec.)											
	1/1000	1/500	1/250	1/25	1/60	1/30	1/15	1/8	1/4	1/2	1	B
FP	Red	Red	Red	Red	Red	Green	Green	Green	Green	Green	Green	Green
M	Red	Red	Red	Red	Red	Green	Green	Green	Green	Green	Green	Green
MF	Red	Red	Red	Red	Red	Green	Green	Green	Green	Green	Green	Green
Speedlight	Red	Red	Red	Green	Green	Green	Green	Green	Green	Green	Green	Green

Green Synchronized

Red Cannot be used



## TIPS ON CAMERA CARE

Tough and durable though your Nikon FM is, it is a precision optical instrument, and careless or rough handling can cause irreparable damage. Observe the following tips, and the camera will always work as perfectly as the day you bought it.

- Remember that the camera's controls are designed to operate with a minimum of pressure. If you find yourself exerting extra force, take it as a warning that you're doing something wrong.
- Keep all lens and prism surfaces free from dust, dirt and fingerprints. These not only impair viewing—they also generally result in a deterioration of optical performance. Clean such surfaces either with a blower-type brush or with lens tissue moistened with absolute alcohol. Never use lens tissue dry—it will scratch the lens. In general, avoid using cleaning fluids and lens tissue containing silicone (i.e., eyeglass tissue).
- When loading or unloading film, ensure that the interior of the camera body is free of dust, grit or chips of film. Use a blower brush to remove such foreign articles. Avoid touching all internal surfaces, particularly the shutter mechanism and film pressure plate.
- When mounting or removing lenses, prevent the entry of foreign matter, and take extra care not to damage the rear portion of the lens. Use a blower-type brush to do your cleaning.
- Use the cleaning cloth to clean the external surfaces of the

camera body.

- If condensation should form on the lens surfaces (i.e., when the camera is exposed to sudden temperature changes or to high humidity), dry the camera thoroughly at room temperature without using anything before storing it in a cool, dry place.
- Should you drop the camera accidentally on the floor or in water, take it to an authorized Nikon dealer or service facility for servicing immediately.

It is best to store the camera in a case or something similar when you're not using it. In this case, make sure the camera's shutter or self-timer is not cocked; also, don't leave film in the camera if it is to be stored for a long period of time.

Do not lubricate any part of the camera yourself; all such work should be left to an authorized Nikon dealer or service facility. It is good practice to test your camera for proper operation before preceding to your shooting assignment. Observe normal battery handling procedures to ensure your camera delivers maximum performance at all times: (1) Install batteries correctly, (2) clean them periodically with a dry cloth; (3) remove batteries when the camera is stored for a long period of time; (4) store unused batteries in a cool, dry place; (5) change weak batteries promptly to prevent leakage within the camera. Also; dispose of used batteries properly (i.e., they should never be burnt), and keep them out of the reach of children. For details on battery performance by brand, refer to the literature available from the manufacturer.

## MOUNTING AND REMOVING LENSES

To mount a lens fitted with a meter coupling ridge, first make sure that the camera's meter coupling lever is in the normal position (i.e., it protrudes from the camera's lens mounting flange). Position the lens in the flange so that the mounting index on the lens is aligned with the mounting index on the camera body. Then, twist the lens counterclockwise until it clicks and locks into place. The lens' maximum aperture is automatically indexed to the camera's meter as soon as it is mounted.

To mount a lens not fitted with a meter coupling ridge, first make sure that the camera's meter coupling lever is locked up out of the way by pushing the coupling lever release and manually lifting the lever up. Mounting procedure is the same

as described previously. Remember that stop-down exposure measurement is required for lenses of this type (see page 26). To remove the lens from the camera body, press the lens release button and keep it depressed while twisting the lens clockwise as far as it will go. Lift the lens out when it comes loose.

Note: The Nikon Fisheye 6mm f/5.6 and OP 10mm f/5.6 cannot be used with the Nikon FM, because the camera does not have a provision for locking the mirror in the "up" position.



### M D-1 2 Motor Drive Unit

The Nikon FM's own compact motor drive. Handsomely finished in black and durably constructed, the MD-12 attaches to the FM in seconds, requiring absolutely no modification or special adjustment of the camera body. Continuous and single frame operation available, with a maximum shooting speed of 3.5 frames per second from 1/125 sec. to 1/1000 sec. Firing speed automatically adjusted as shutter speed is adjusted. Built-in battery pack contributes to overall reduced size and weight. Fitted with remote control socket for use with Nikon remote control accessories such as the MT-1 Intervalometer and the MOO-1 Radio Remote Control Set.





---

## Camera Cases

Recommended for storing camera body and lenses. Different sizes available to accommodate most Nikkor lenses.

## Lens Hoods

Recommended to prevent extraneous light from striking the lens and causing flare and ghost; also useful for protecting the lens. All kinds of models to match all kinds of Nikkor lenses.

## Filters

A wide selection of sizes and types to meet the needs of color or black-and-white photography. These filters work best with Nikkor lenses, and vice versa. Also useful for protecting the front portion of the lens.

## FEATURES/SPECIFICATIONS

**Type of camera:** 35mm single-lens reflex (SLR)

**Picture format:** 24mm x 36mm (35mm film)

**Lens mount:** Nikon F mount (bayonet type)

Lenses available: Nikkor 50mm f/1.4, f/1.8 or 50mm f/1.2 as standard; more than 50 interchangeable Nikkor lenses in all

**Viewing system:** Fixed eye-level pentaprism viewfinder with approx. 93% frame coverage; shutter speed selected indicated in the viewfinder; lens aperture setting indicated in the viewfinder when lens in use is fitted with a meter coupling ridge and an aperture direct-readout lens aperture scale; matte Fresnel focusing screen with central split-image rangefinder spot and microprism ring (similar to Nikon Type K screen)

**Exposure metering:** Through-the-lens, center-weighted, full aperture exposure measurement with Nikkor lenses fitted with meter coupling ridge; stop-down exposure measurement applies for other lenses; exposure correctly set by adjusting shutter speed and/or lens aperture until correct exposure indicator LED lights up; meter cross-coupled with both lens diaphragm and shutter speed controls; metering range EV 1 to EV 18 (i.e., f/1.4, 1 sec. ~ f/16, 1/1000 sec.) with 50mm f/1.4 lens at ASA 100; built-in meter coupling lever can be locked up, enabling use with both AI-type and non-AI-type Nikkor lenses; ASA range 12 ~ 3200; aperture coupling range f/1.2 ~

f/32; meter powered by two 1.5 silver-oxide batteries

**Shutter:** Vertical-travel focal-plane shutter with speeds from 1 to 1/1000 sec., plus “B”

**Reflex mirror:** Automatic instant-return type

**Self-timer:** Can be set for approx. 8 ~ 14 sec. delay; setting “cancellable”

**Film advance lever:** Single-stroke type; 30° stand-off position switches meter on (flush position switches meter off); 135° winding angle

**Frame counter:** Additive type; automatically resets to “S.” two frames before “0,” when camera back is opened

**Flash synchronization:** Built-in ISO-type hot-shoe contact with safety switch for synchronization with electronic flash units at speeds up to 1/125 sec.; sync terminal provided

**Film rewind:** Manual crank-type

**Camera back:** Hinged, swing-open type; removable; memo holder provided

**Dimensions:** Approx. 142mm x 89.5mm x 60.5mm

**Weight:** Approx. 590g (body only)

