

PENTAX™

SLR Digital Camera

**istDs*

Operating Manual



PictBridge

For optimum camera performance, please read the Operating Manual before using the camera.

Thank you for purchasing the PENTAX **istDS* Digital Camera. Please read this manual before using the camera in order to get the most out of all the features and functions. Keep this manual safe, as it can be a valuable tool in helping you to understand all the camera's capabilities.

Lenses you can use

In general, lenses that can be used with this camera are DA, D FA and FA J lenses and lenses that have an Aperture **A** (Auto) position.

To use any other lens or accessory, see page 37 and 179.

Regarding copyrights

Images taken using the **istDS* that are for anything other than personal enjoyment cannot be used without permission according to the rights as specified in the Copyright Act. Please take care, as there are even cases where limitations are placed on taking pictures even for personal enjoyment during demonstrations, industrial enterprise or as items for display. Images taken with the purpose of obtaining copyrights also cannot be used outside the scope of use of the copyright as laid out in the Copyright Act, and care should be taken here also.

Regarding trademarks

- PENTAX and smc PENTAX are trademarks of PENTAX Corporation.
- The SD logo  is a trademark.
- All other brands or product names are trademarks or registered trademarks of their respective companies.

To users of this camera

- There is a possibility that recorded data may be erased or that the camera may not function correctly when used in surroundings such as installations generating strong electromagnetic radiation or magnetic fields.
- The liquid crystal panel used in the LCD display is manufactured using extremely high precision technology. Although the level of functioning pixels is 99.99% or better, you should be aware that 0.01% or fewer of the pixels may not illuminate or may illuminate when they should not. However, this has no effect on the recorded image.

This product supports PRINT Image Matching III. PRINT Image Matching enabled digital still cameras, printers and software help photographers to produce images more faithful to their intentions. Some functions are not available on printers that are not PRINT Image Matching III compliant.

Copyright 2001 Seiko Epson Corporation. All Rights Reserved.

PRINT Image Matching is a trademark of Seiko Epson Corporation.

The PRINT Image Matching logo is a trademark of Seiko Epson Corporation.

Regarding PictBridge

PictBridge allows the user to connect the printer and digital camera directly, using the unified standard for the direct printout of images. You can print images directly from the camera through a few simple operations.

- There is a possibility that the illustrations and the display screen of the LCD monitor in this manual are different from the actual product.

FOR SAFE USE OF YOUR CAMERA

We have paid close attention to the safety of this product. When using this product, we request your special attention regarding items marked with the following symbols.



Warning

This symbol indicates that violating this item could cause serious personal injury.



Caution

This symbol indicates that violating this item could cause minor or medium personal injury, or material loss.

ABOUT THE CAMERA



Warning

- Do not disassemble or modify the camera. High voltage areas are present inside the camera, with the risk of electric shock.
- If the camera interior is exposed due to dropping or otherwise damaging the camera, never touch the exposed portion. There is the risk of electric shock.
- To avoid the risk of it being swallowed by mistake, keep the SD Memory Card out of the reach of small children. Seek medical attention immediately if accidentally swallowed.
- Wrapping the strap around your neck is dangerous. Take care that small children do not hang the strap over their necks.
- Do not look directly at the sun through the camera with the telephoto lens attached, as viewing the sun may damage your eyes. Viewing directly with the telephoto lens may lead to a loss of eyesight.
- Be sure to store batteries out of the reach of children. Seek medical assistance immediately if accidentally swallowed.
- Always use the AC adapter exclusively for this product, with the specified power and voltage. Using an AC adapter not exclusive to this product, or using the exclusive AC adapter with an unspecified power or voltage can cause a fire, electric shock, or camera breakdown.
- If any irregularities occur during use, such as smoke or a strange odor, stop use immediately, remove the batteries or the AC adapter, and contact your nearest PENTAX service center. Continued use could cause a fire or electric shock.
- During thunderstorms, unplug and discontinue use of the AC adapter. Continued use could cause equipment failure, a fire, or electric shock.



Caution

- Do not short the battery or dispose of the battery in fire. Do not disassemble the battery. The battery could explode or catch fire.
- Do not charge any batteries other than rechargeable Ni-MH batteries. The battery could explode or catch fire. The batteries that can be used in this camera, only the Ni-MH battery can be recharged.
- Remove the battery from the camera immediately if it becomes hot or begins to smoke. Be careful not to burn yourself during removal.
- Some portions of the camera heat up during use. There is the risk of low temperature burns when holding such portions for long periods.
- Do not place your finger or cover with clothing when discharging the flash. Fingers or clothing may be burned.

PRECAUTIONS FOR BATTERY USAGE

- Only use specified batteries with this camera. Use of other batteries can cause overheating or explosion.
- Replace the batteries at the same time. Do not mix battery brands, type or an old battery with a new one. It may cause explosion or overheating.
- The battery should be inserted correctly with regard to polarity (+ and -) marked on the battery and the camera.
- AA lithium batteries, AA alkaline batteries and CR-V3 are not rechargeable. Do not disassemble the battery. Recharging and disassembling can cause explosion or overheating.

Care to be Taken During Handling

- Take the Worldwide Service Network that is included in the package. This will be useful if you experience problems abroad.
- When the camera has not been used for a long time, confirm that it is still working properly, particularly prior to taking important pictures (such as at a wedding or during traveling). Contents of the recording cannot be guaranteed if recording, playback or transferring your data to a computer, etc. is not possible due to a malfunction of your camera or recording media (SD Memory Card), etc.
- Do not clean the product with organic solvents such as thinner or alcohol benzene.
- Do not subject to high temperatures or high humidity. Do not leave the camera in a vehicle, as the temperature can get very high.

- Do not store the camera with preservatives and chemicals. Storage in high temperatures and high humidity can cause molding. Remove from case and store in a dry and well-ventilated location.
- This camera is not waterproof, and cannot be used in the rain or where the camera could get wet.
- Do not subject the camera to strong vibrations, shocks, or pressure. Use a cushion to protect the camera from vibrations of motorcycles, automobiles, or ships.
- The temperature range for camera use is 0°C to 40°C.
- The LCD display may appear black under high temperatures, but will return to normal as temperatures normalize.
- The LCD display may respond more slowly at low temperatures. This is due to liquid crystal properties, and is not a fault.
- Periodic inspections are recommended every one to two years to maintain high performance.
- Sudden temperature changes will cause condensation on the inside and outside of the camera. Place the camera in your bag or a plastic bag, retrieving the camera after decreasing the temperature difference.
- Avoid contact with garbage, mud, sand, dust, water, toxic gases, or salts. These could cause a camera breakdown. Wipe dry any rain or water drops on the camera.
- Refer to “Precautions When Using the SD Memory Card” (p.30) regarding the SD Memory Card.
- Use a blower or lens brush to remove dust accumulated on the lens or viewfinder. Never use a spray blower for cleaning as it may damage the lens.
- Please do not press forcefully on the LCD monitor. This could cause breakage or malfunction.

Contents

FOR SAFE USE OF YOUR CAMERA.....	1
ABOUT THE CAMERA.....	1
PRECAUTIONS FOR BATTERY USAGE.....	2
Care to be Taken During Handling.....	2
Contents.....	4
Composition of the Operating Manual.....	9
Before Using Your Camera	11
<i>*istDS</i> Camera Characteristics.....	12
Checking the Contents of the Package.....	13
Names of Working Parts	14
Camera.....	14
LCD Monitor Indications.....	16
Viewfinder Indications.....	20
LCD Panel Indications.....	22
Getting Started	23
Attaching the Strap	24
Inserting the Batteries	25
Batteries.....	26
Battery Level Indicator.....	27
Approximate Image Storage Capacity and Playback Time (new batteries).....	27
Using the AC Adapter (Optional).....	28
Inserting/Removing the SD Memory Card	29
Recorded Pixels and Quality Level.....	31
Turning the Camera On and Off	32
Initial Settings	33
Setting the Display Language.....	33
Setting the Date and Time.....	35
Attaching the Lens	37
Adjusting the Viewfinder Diopter	39





Basic Operations

41

Basic Shooting Operation	42
Holding the Camera	42
Letting the Camera Choose the Optimal Settings	43
Selecting the Appropriate Capturing Mode for Scenes	47
Using the Zoom Lens	48
Using the Built-in Flash	49
Using the Built-in Flash	49
Other Shooting Modes	53
Continuous Shooting	53
Self-Timer Shooting	55
Remote Control Shooting (Remote Control F: Sold Separately)	59
Using Mirror Lock Up Function to Prevent Camera Shake	62
Playing Back Still Pictures	63
Playing Back Images	63
Enlarging Playback Images	65
Nine-Image Display	66
Slideshow	68
Connecting the Camera to AV Equipment	70
Processing Images with Filters	71
Deleting Images	73
Deleting a Single Image	73
Deleting All Images	74
Deleting Selected Images (from Nine-Image Display)	75
Protecting Images from Deletion (Protect)	77
Setting the Printing Service (DPOF)	79
Printing Single Images	79
Settings for All Images	81
Printing Using PictBridge	83
Setting Transfer Modes	84
Connecting the Camera to the Printer	85
Printing Single Images	86
Printing All Images	88
Printing Images Using the DPOF Settings	90
Disconnecting the Cable from the Printer	90

Menu Reference

91

Using the Button Functions	92
Capture Mode	92
Playback	94
Using the Menu	96
How to Operate the Menu.....	96
[ Rec. Mode] Menu Setting Items	98
[ Playback] Menu Setting Items	98
[ Set-up] Menu Setting Items	99
[ Custom] Menu Setting Items	100
Using the Fn Menu	102
Capture Mode	102
Playback	103
Using the Mode Dial.....	104

Function Reference

107

Setting the Recorded Pixels and Quality Level.....	108
Setting the Image Tone	108
Setting the Recorded Pixels	109
Setting the Quality Level.....	110
Setting the Saturation/Sharpness/Contrast	111
Setting the White Balance	112
Setting the Sensitivity	115
Setting the Color Space.....	117
Focusing	118
Using the Autofocus.....	118
Adjusting the Focus Manually (Manual Focus).....	121
Selecting the Focus Point (Focus Point).....	123
Fixing the Focus (Focus Lock).....	125
Setting the Exposure	127
Effect of Aperture and Shutter Speed.....	127
Selecting the Metering Method	130
Changing the Exposure Mode	132
Setting the Exposure	141
Changing the Exposure and Shooting (Auto Bracket).....	143
Setting Auto Bracket.....	145
Using the Built-in Flash	146
Compensating Flash Output.....	146
Allowing Shooting while Charging Flash.....	147
Flash Characteristics in Each Exposure Mode	147

Distance and Aperture when Using the Built-in Flash	149
DA, D FA , FA J, FA and F Lens Compatibility with the Built-in Flash	151
Using an External Flash (Optional).....	153
Settings During Playback.....	160
Changing Playback Display Method	160
Displaying Hot Spot Warning.....	160
Setting the Slideshow Display Interval.....	161
Camera Settings.....	162
Formatting the SD Memory Card.....	162
Turning the Beep On and Off.....	163
Changing the Date and Time and the Display Style	163
Setting the World Time	164
Setting the Display Language.....	167
Turning the Guide Display On and Off.....	167
Adjusting the Brightness of the LCD Monitor.....	168
Selecting the Video Output Format.....	168
Setting Auto Power Off.....	169
Resetting the File Number.....	169
Setting the Instant Review.....	170
Resetting to Default Settings.....	171
Resetting Rec. Mode/Playback/Set-up Menu	171
Resetting the Custom Function Menu	172

Appendix 173

Default Settings.....	174
Functions Available with Various Lens Combinations	177
Notes on [Using Aperture Ring]	179
Cleaning the CCD.....	180
Optional Accessories	182
AC Adapter D-AC10	182
Cable Switch CS-205.....	182
Remote Control F	182
Flash Accessories.....	182
For Viewfinder.....	183
Camera Case.....	184
Others	184
Error Messages	185
Troubleshooting.....	187

Main Specifications	189
Specification for Remote Control (Optional)	191
Glossary	192
Index	196
WARRANTY POLICY	200

Composition of the Operating Manual

This operating manual contains the following chapters.

1 Before Using Your Camera

Explains camera characteristics, accessories and the names of various parts.

2 Getting Started

Explains your first steps from purchasing the camera to taking pictures. Be sure to read it and follow the instructions.

3 Basic Operations

Explains the procedures for taking, playing back, and printing still pictures. Read it to learn all of the basic operations about capturing, playing back, and printing.

4 Menu Reference

Explains the functions of **istDS* by buttons and menus.



5 Function Reference

Introduces functions to further enhance your **istDS* experience.

6 Appendix

Explains troubleshooting, introduces optional accessories and provides various resources.

The symbols used in this operating manual are explained below.

	Shows reference page number explaining a related operation.
	Shows useful information.
	Shows precautions to take when operating the camera.

1 Before Using Your Camera

Check the package contents and names of working parts before use.

<i>*istDS</i> Camera Characteristics	12
Checking the Contents of the Package	13
Names of Working Parts	14

- Features a 23.5×15.7 mm CCD with 6.1 million effective pixels for high precision and a wide dynamic range.
- Features an AF sensor with 11 focusing points. The central 9 are wide cross area sensors.
- Improved manual focusing using a viewfinder similar to a conventional 35 mm SLR camera, with 0.95× magnification. Also features a superimpose function in which the focus points on the viewfinder illuminate red.
- Use CR-V3, AA lithium batteries, rechargeable AA Ni-MH batteries or AA alkaline batteries.
- Concepts of Universal Design have been implemented to various parts of the camera. The high resolution LCD monitor features large characters, and buttons are easier to use.

The captured area (view angle) will differ for ***istDS** and 35 mm SLR cameras even if the same lens is used because the format size for 35 mm film and CCD are different.

Sizes for 35 mm film and CCD

35 mm film	: 36×24 mm
*istDS CCD	: 23.5×15.7 mm

Angles of view being equal, the focal length of a lens used with a 35 mm camera must be approximately 1.5 times longer than that of ***istDS**. To obtain a focal length framing the same area, divide the focal length of the 35 mm lens by 1.5.

Example) To capture the same image as a 150 mm lens attached to a 35 mm camera

$$150 \div 1.5 = 100$$

Use a 100 mm lens with the ***istDS**.

Inversely, multiply the focus distance of the lens used with ***istDS** by 1.5 to determine the focus distance for 35 mm cameras.

Example) If 300 mm lens is used with ***istDS**

$$300 \times 1.5 = 450$$

Focus distance is equivalent to 450 mm lens on a 35 mm camera.

The following accessories are packaged with your camera.
Check that all accessories are included.



Hot shoe cover F_k
(Installed on camera)



Eyecup F_l
(Installed on camera)



ME Viewfinder cap



Body mount cover
(Installed on camera)

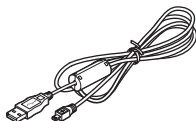

USB cable
I-USB17

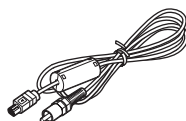

Video cable
I-VC28



Software (CD-ROM)
S-SW28

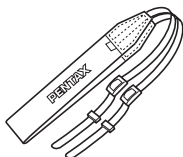

Strap
O-ST10

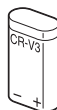

Lithium batteries
CR-V3 (two)

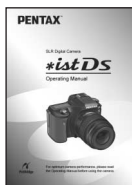

Operating Manual
(this manual)

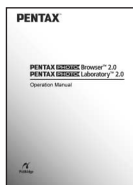

PENTAX PHOTO Browser 2.0/
PENTAX PHOTO Laboratory 2.0
Operating Manual

1

Before Using Your Camera

Camera

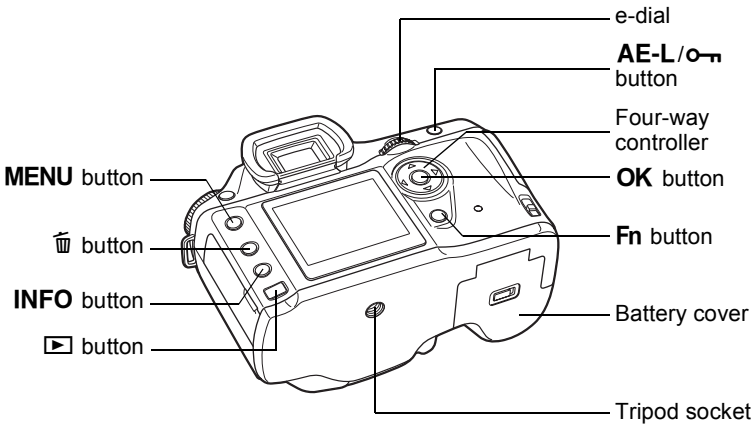
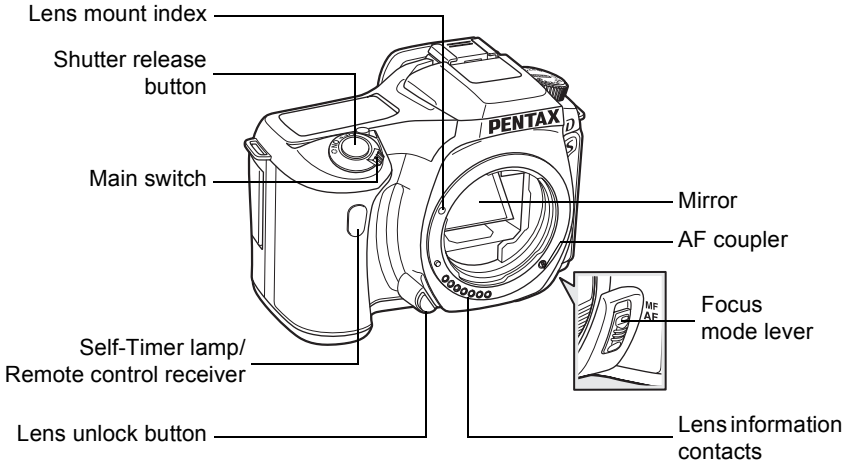

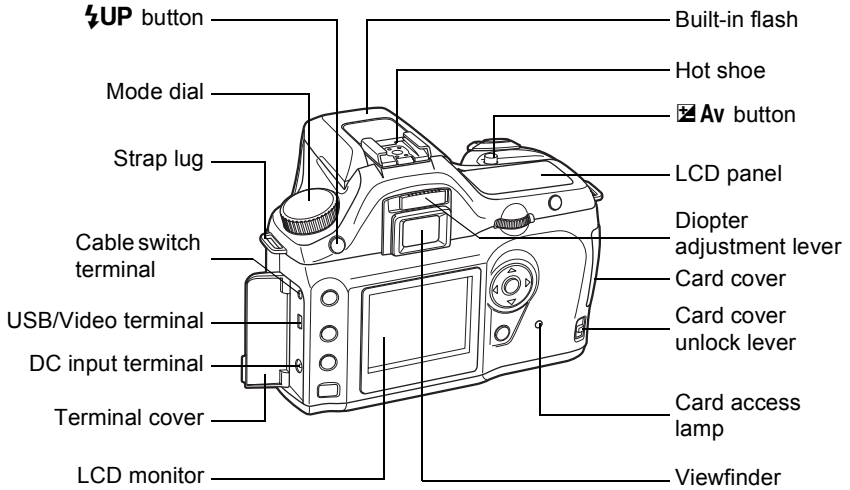

LCD Monitor Indications

The following indicators appear on the LCD monitor depending on the status of the camera.

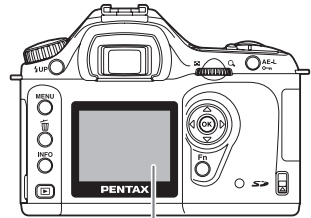

LCD monitor

While Power is On or Operating Mode Dial

Guides appear on the LCD monitor for three seconds when powered on or setting dial mode.



Select [Off] for [Guide display] in [X↓ Set-up] to not show indicators. (p.99)

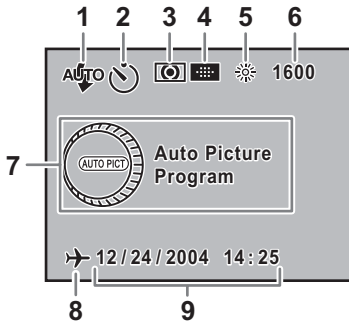

- 1 Flash mode
(Active mode appears) (p.49)
- 2 Drive mode (p.102)
- 3 AE metering (p.130)
- 4 Switch distance measuring point
(p.123)
- 5 White balance (p.112)
- 6 Sensitivity (p.115)
- 7 Shooting mode
(Mode dial position) (p.104)
- 8 World time warning display (p.164)
- 9 Date and time (p.163)

* Indicators 3,4,5 and 6 only appear when the setting other than the default setting is selected. 8 only appears when World Time is On.

Playback

The camera switches screen displays every time you press **INFO** button during playback.



You can change the information initially displayed by pressing the **INFO** button. (p.160)

● Detailed Information

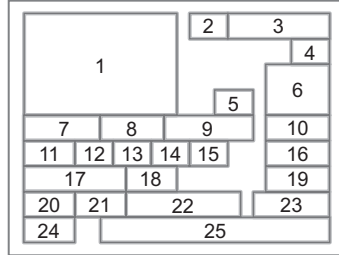
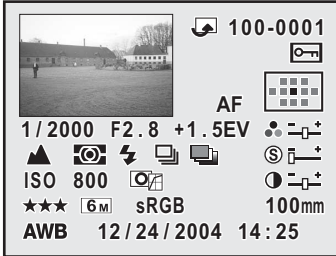

- | | | | |
|----|---|----|--------------------------------|
| 1 | Captured images | 13 | Flash mode (p.49) |
| 2 | Rotate icon (p.64) | 14 | Drive mode (p.102) |
| 3 | Image folder number and file number (p.169) | 15 | Auto bracket (p.145) |
| 4 | Protect icon (p.77) | 16 | Sharpness (p.111) |
| 5 | Focus mode (p.118) | 17 | ISO sensitivity (p.115) |
| 6 | Focus point information (p.123) | 18 | Image finishing (p.108) |
| 7 | Shutter speed (p.134) | 19 | Contrast (p.111) |
| 8 | Aperture (p.136) | 20 | Quality (p.110) |
| 9 | EV compensation (p.141) | 21 | Recorded pixels (p.109) |
| 10 | Saturation (p.111) | 22 | Color space (p.117) |
| 11 | Shooting mode (p.104) | 23 | Lens focal length |
| 12 | AE metering (p.130) | 24 | White balance (p.112) |
| | | 25 | Captured date and time (p.163) |

● Histogram Display

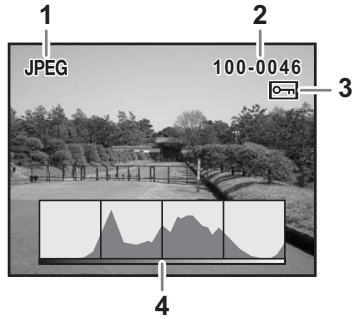

- 1 Capture quality
- 2 Image folder number and file number (p.169)
- 3 Protect icon (p.77)
- 4 Histogram



- Areas where blooming occurred blink if Hot spot warning is on. (p.160)
- Press the four-way controller (▲▼) in the histogram display to move the Histogram display position up or down.

Viewfinder Indications

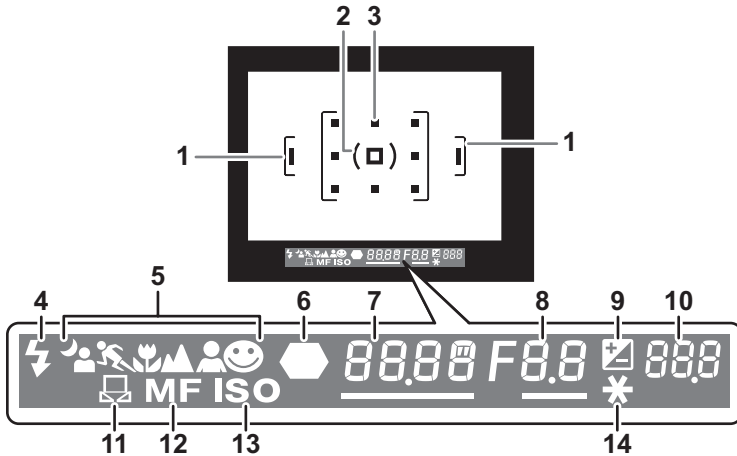

- 1 Autofocus frame (p.39)
- 2 Spot metering frame (p.130)
- 3 Focus point (p.123)
- 4 Flash status (p.49)
Appears when flash is available and blinks when flash is recommended but not set.
- 5 Picture mode icon (p.47)
Icon for Picture mode in use appears.
 🌃 Night Scene Portrait, 🏃 Moving Object, 🌸 Macro, 🏔 Landscape, 👤 Portrait, 😊 Normal
- 6 Focus indicator (p.44)
Appears when image is focused.
- 7 Shutter speed (p.134)
Shutter speed when capturing or adjusting (underlined when shutter speed can be adjusted with e-dial).
- 8 Aperture (p.136)
Aperture when capturing or adjusting (underlined when aperture can be adjusted with e-dial).
- 9 EV compensation (p.141)
Appears when EV compensation is available or in use.
Blinks slowly when compensating flash output.
Blinks quickly when compensating exposure and flash output.
Adjusted value appears where number of recordable images is shown.

- 10** Number of recordable images/EV compensation
Show the number of recordable images with current quality and recorded pixel setting.
Show the number of continuous shooting recordable images. (p.100)
EV compensation value appears when EV compensation is being adjusted. (p.133)
The difference with the appropriate exposure value appears if exposure mode is **M**. (p.138)
- 11** Manual white balance (p.113)
Appears when manual white balance is in use and blinks while adjusting.
- 12** Manual focus (p.121)
Appears when focus mode is **MF**.
- 13** ISO sensitivity warning (p.116)
Appears when warning value is exceeded.
- 14** AE lock indicator (p.142)
Appears during AE lock.



The focus points used for autofocus when shutter release button is pressed halfway is superimposed red. (p.123)

LCD Panel Indications

The following information appears in the LCD panel on top of the camera.

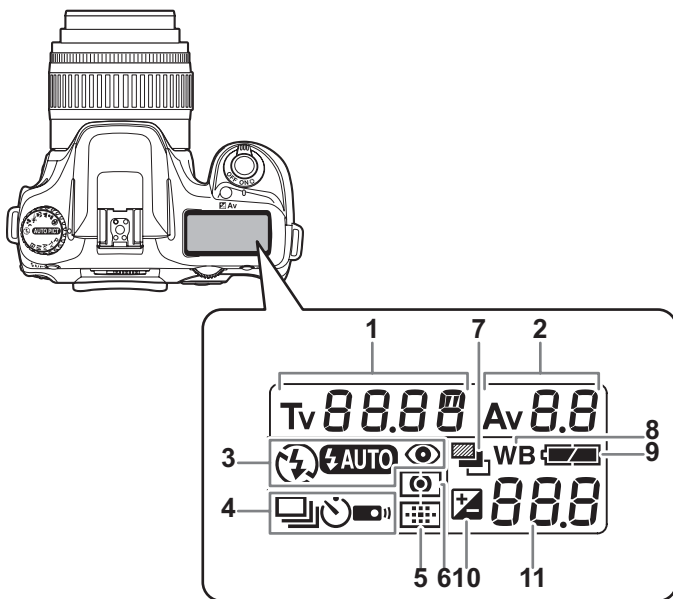

- | | |
|--|---|
| <p>1 Shutter speed (p.134)</p> <p>2 Aperture (p.136)</p> <p>3 Flash mode (p.49)</p> <p>⚡ : Built-in flash is ready
(when blinking, flash should
be used or incompatible
lens is being used)</p> <p>⚡ : Flash off</p> <p>⚡AUTO : Auto discharge</p> <p>👁 : Red-eye reduction flash on</p> <p>4 Drive Mode (p.102)</p> <p>□ : Single frame shooting</p> <p>📄 : Continuous shooting</p> <p>🕒 : Self-Timer shooting</p> <p>📡 : Remote control shooting</p> <p>5 Focus point indicator (p.123)</p> <p>No indicator : Auto</p> <p>⦿ : Select</p> <p>☉ : Center</p> | <p>6 AE metering (p.130)</p> <p>No indicator:
Multi-segment metering</p> <p>☉ : Center-weighted metering</p> <p>☐ : Spot metering</p> <p>7 Auto bracketing (p.145)</p> <p>8 White balance (p.112)
(Not displayed when set to Auto)</p> <p>9 Battery level</p> <p>10 EV compensation (p.141)</p> <p>11 Number of recordable images/
EV compensation value/PC (Pb)
(PC = Personal Computer (mass
storage), Pb = PictBridge)</p> |
|--|---|

2 Getting Started

This chapter explains your first steps from purchasing the camera to taking pictures. Be sure to read it and follow the instructions.

Attaching the Strap	24
Inserting the Batteries	25
Inserting/Removing the SD Memory Card	29
Turning the Camera On and Off	32
Initial Settings	33
Attaching the Lens	37
Adjusting the Viewfinder Diopter	39

Attaching the Strap

2

Getting Started

- 1 Pass the end of the strap through the strap lug, then secure on the inside of the clasp.

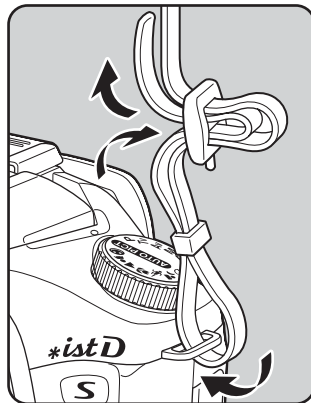

- 2 Pass the other end of the strap through the other strap lug on the camera, then secure on the inside of the clasp.

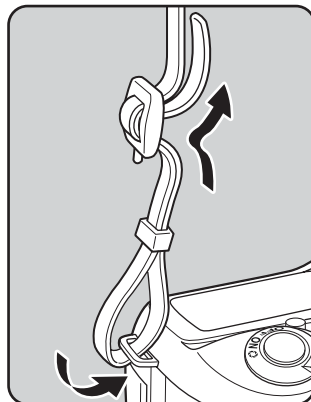

Insert batteries into the camera. Use two CR-V3 or four AA Ni-MH batteries, AA lithium batteries, or AA alkaline batteries.



- CR-V3, AA lithium batteries and AA alkaline batteries are not rechargeable.
- Do not open the battery cover or remove the batteries while the power is on.
- Remove the batteries when you will not use the camera for a long while. The battery may leak.
- If the date and time settings have been reset when you insert new batteries after a long while, follow the procedure for “Setting the Date and Time”. (p.35)
- Insert batteries correctly. Batteries inserted incorrectly may cause a camera breakdown.
- Replace all the batteries at the same time. Do not mix battery type, brands or an old battery with a new one.

2

Getting Started

- 1 Push and hold the battery cover unlock lever as shown in the illustration (①), and slide the battery cover toward the lens (②), and then flip open.**

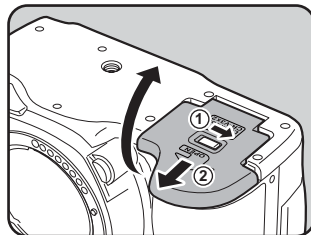

- 2 Insert the batteries according to the +/– indicators in the battery chamber.**

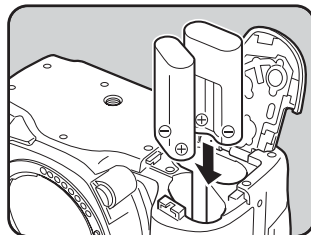

3

Press down on the batteries with the battery cover (①) and slide it as shown in the illustration (②) to close.

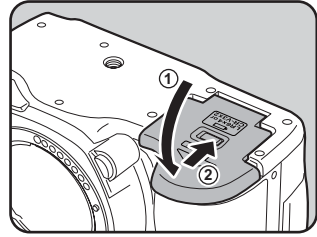

2



- Use the AC adapter (optional) when using the camera for a prolonged period. (p.28)
- Check the battery orientation if the camera does not operate properly after replacing the batteries.





Batteries

You can use four kinds of batteries with your camera. Battery performance differs by type. Please choose the type that best suits your purpose.

CR-V3	The provided CR-V3 is a long-life battery and is convenient when traveling.
AA Ni-MH rechargeable batteries	These are rechargeable and are economical.
AA lithium batteries	Recommended in cold climates.
AA alkaline batteries	Recommended only for emergencies such as when your usual batteries run out. These are readily available but may not support all the camera functions under certain conditions.

Battery Level Indicator

You can confirm remaining battery level by checking the  displayed on the LCD panel.

	lit	: Battery is full.
↓		
	lit	: Battery is running low.
↓		
	lit	: Battery is almost empty.
↓		
	blink	: The camera turns off after displaying a message.

Approximate Image Storage Capacity and Playback Time (new batteries)

Batteries	(Temperature)	Normal recording	Flash photography		Playback time
			50% use	100% use	
CR-V3	(23°C)	850	750	650	700 minutes
	(0°C)	560	500	410	470 minutes
AA lithium batteries	(23°C)	750	650	550	470 minutes
	(0°C)	670	570	470	400 minutes
AA Ni-MH rechargeable batteries	(23°C)	560	500	440	350 minutes
	(0°C)	500	440	380	300 minutes
AA Alkaline Batteries	(23°C)	90	70	50	140 minutes
	(0°C)	Not applicable	Not applicable	Not applicable	70 minutes

The still picture storage capacity is based on measuring conditions in accordance with CIPA standards and the playback time is based on PENTAX measuring conditions. Some deviation from the above figures may occur in actual use depending on shooting mode and shooting conditions.



- Battery performance temporarily decreases as the temperature decreases. When using the camera in cold climates, have extra batteries on hand and keep them warm in your pocket. Battery performance will return to normal when returned to room temperature.
- AA alkaline batteries may not support all the camera functions. We do not recommend their use except in emergencies.
- Have extra batteries ready when traveling overseas, taking pictures in cold climates, or when you will be taking a lot of pictures.

Using the AC Adapter (Optional)

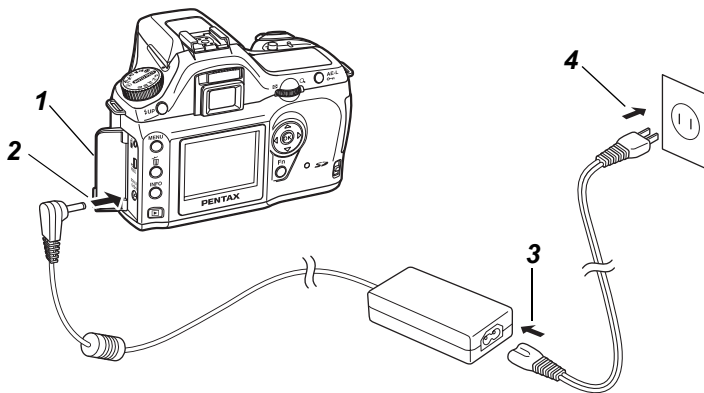

We recommend using the AC adapter D-AC10 (optional) when using the LCD monitor for a long time or when connecting to your PC.

- 1** Make sure the camera is turned off before opening the terminal cover.
- 2** Connect the DC terminal on the AC adapter to the DC input terminal on the camera.
- 3** Connect the AC plug cord to the AC adapter.
- 4** Plug the AC cord into the power outlet.



- Make sure the camera is turned off before connecting or disconnecting the AC adapter.
- Make sure connections are secure between the camera, AC adapter, AC plug cord terminal and the power outlet. SD Memory Card and data will be corrupted if disconnected while camera is recording or reading data.



- Be sure to read the AC adapter D-AC10 operating manual when using the AC adapter.
- The rechargeable batteries in your camera will not charge when connected to the AC adapter.

Inserting/Removing the SD Memory Card

Captured images are recorded on the SD Memory Card. Make sure the camera is turned off before inserting or removing the SD Memory Card (market product).



Do not remove the SD Memory Card while card access lamp is lit.

- 1 Press the card cover unlock lever in the indicated direction.**

Card cover opens.

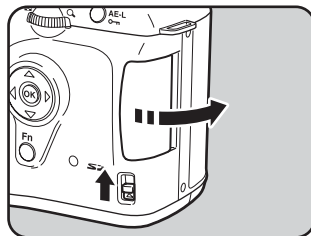

- 2 Insert the card all the way with the SD Memory Card label toward the LCD monitor.**

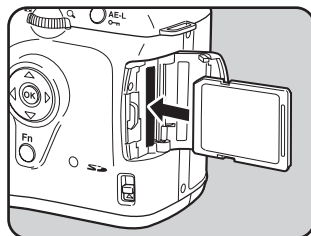

- 3 Close the card cover.**

Push the SD Memory Card in once to remove.

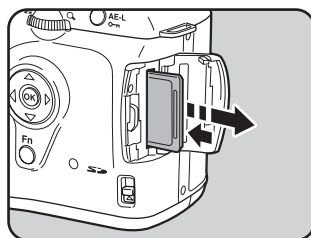
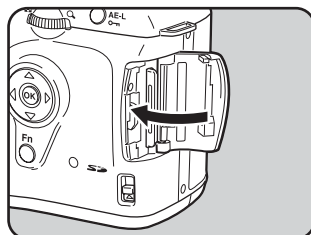

Precautions When Using the SD Memory Card

- The SD Memory Card is equipped with a write-protect switch. Setting the switch to LOCK protects the existing data by prohibiting recording of new data, deletion of existing data or formatting of the card.
- Care should be taken when removing the SD Memory Card immediately after using the camera because the card may be hot.
- Do not remove the SD Memory Card or turn the camera off while data is being saved to the card, images are being played back, or the camera is connected to a computer with the USB cable. This may cause the data to be lost or the card to be damaged.
- Do not bend the SD Memory Card or subject it to violent impact. Keep it away from water and store away from high temperatures.
- Do not remove the SD Memory Card during formatting. The card may be damaged beyond use.
- Data on the SD Memory Card may be deleted in the following circumstances. PENTAX does not accept any liability for data that is deleted if
 - (1) the SD Memory Card is mishandled by the user.
 - (2) the SD Memory Card is exposed to static electricity or electrical interference.
 - (3) the card has not been used for a long time.
 - (4) the card is ejected or the battery is removed while the data on the card is being recorded or accessed.
- The SD Memory Card has a limited service life. If it is not used for a long time, the data on the card may become unreadable. Be sure to make a backup of important data on a computer.
- Avoid using or storing the card where it may be exposed to static electricity or electrical interference.
- Avoid using or storing the card in direct sunlight or where it may be exposed to rapid changes in temperature or to condensation.
- For information on compatible SD Memory Card, visit the PENTAX website or contact your nearest PENTAX customer service center.
- Format new SD Memory Cards. Also format SD Memory Card used with other cameras.  Formatting the SD Memory Card (p.162)

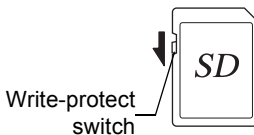

Recorded Pixels and Quality Level

Choose the number of pixels (size) and quality level (data compression rate) of pictures according to how you intend to use the pictures you have taken.

Pictures with larger recorded size or the more ★ are clearer when printed. The number of pictures that can be taken (the number of pictures that can be recorded on an SD Memory Card) becomes less with larger file sizes. The quality of the captured photo or printed picture depends on the quality level, exposure control, resolution of the printer and a variety of other factors so you do not need to select more than the required number of pixels. For example, to print in postcard size, 1.5M size is enough. Set the appropriate recorded size and quality level depending on purpose.

Choose the appropriate number of recorded pixels and quality level for images on the [📷 Rec. Mode] menu.

☞ Setting the Recorded Pixels (p.109)

☞ Setting the Quality Level (p.110)

● Recorded Pixels, Quality Level and Approximate Image Storage Capacity

Quality Level Recorded Pixels		RAW	★★★ Best	★★ Better	★ Good
		6M (3008×2008)	11	—	—
	(3008×2000)	—	34	70	117
4M (2400×1600)		—	51	96	161
1.5M (1536×1024)		—	106	173	271

- The above table shows the approximate image storage capacity and recording time when using a 128MB SD Memory Card.
- The above figures may vary depending on the subject, shooting conditions, shooting mode and SD Memory Card, etc.

1 Move the main switch to [ON] position.

The camera will turn on.

Move the main switch to [OFF] position to turn off the camera.

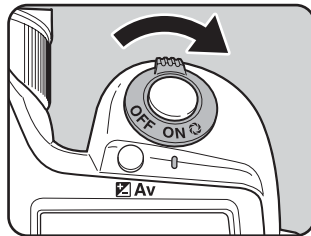

- Always turn the camera OFF when not in use.
- The power will automatically turn off when you do not perform any operations within a set period of time. (Default setting is 1 minute) (p.169)

The first time the camera is turned on after purchasing, the “Initial Settings” screen appears on the LCD monitor. Follow the procedure below to set the language displayed on the LCD monitor and the current date and time. Once setting is done, these will not need to be set again when turning your camera on.

Setting the Display Language

You can choose the language in which the menus, error messages, etc. are displayed from the following: English, French, German, Spanish, Italian, Russian, Korean, Chinese (traditional/simplified) and Japanese.

2

Getting Started

- 1 Press the four-way controller (▶).**

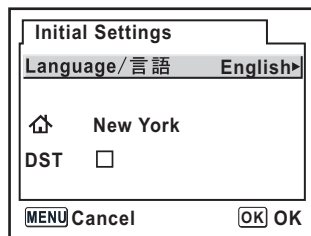

- 2 Use the four-way controller (▲▼◀▶) to select your applicable language.**

The default setting is English.



- 3 Press the OK button.**

4 Press the four-way controller (▼).

The cursor moves to [↕].

5 Press the four-way controller (◀▶) to display the screen for setting the city.

6 Repeat steps 4 and 5 and set daylight saving time (DST).

7 Press the OK button.

The screen for setting the date and time will be displayed.

Setting the Date and Time

Set the current date and time and the display style.

- 1 **Press the four-way controller (▶).**

The frame moves to [mm/dd/yy].

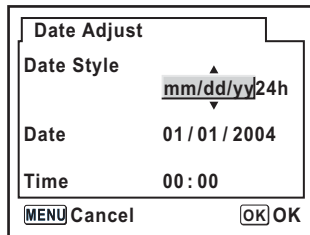

- 2 **Use the four-way controller (▲ ▼) to choose the date style.**

- 3 **Press the four-way controller (▶).**

The frame moves to [24h].

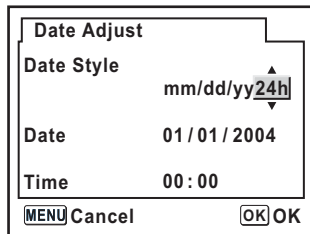

- 4 **Use the four-way controller (▲ ▼) to select 24h (24-hour display) or 12h (12-hour display).**

- 5 **Press the four-way controller (▶).**

The frame returns to [Date Style].

- 6 **Press the four-way controller (▼).**

The frame moves to [Date].

7 Press the four-way controller (▶).

The frame moves to the month.

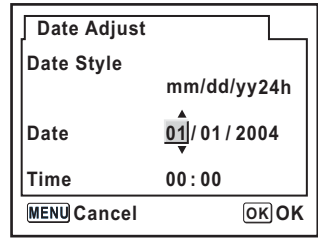

8 Use the four-way controller (▲ ▼) to set the month.

Change the day and year in the same manner.

Next, change the time.

If you select [12h] in Step 4, the setting switches between am and pm depending on the time.

9 Press the OK button.

The camera is ready to take pictures. If you set the date and time with the menu operations, the screen will return to the [X↓ Set-up] menu.

Press the **OK** button again.



- When you finish the settings and press the **OK** button, the camera clock is reset to 00 seconds.
- To set the exact time, press the **OK** button when the time signal (on the TV, radio, etc.) reaches 00 seconds.
- You can change the language and date and time settings with the menu operations. (p.163, p.167)



You can cancel the setting operation and switch to Capture mode during initial settings by pressing the **MENU** button. In this case, the Initial Settings screen will appear again the next time you turn the camera on.

All camera exposure modes are available when using DA, D FA, FA J or other lenses with Aperture **A** (Auto) position. Some functions are restricted when not set to Aperture **A** (Auto). Also see “Notes on [Using Aperture Ring]” (p.179). Other lenses and accessories will not be available with factory default settings. Allow shutter release when using aperture ring in custom function settings. (p.101)



Turn the camera off before attaching or removing the lens to prevent unexpected lens movement.

1 Check that the camera is off.

2 Remove the body mount cover (①) and lens mount cover (②).

Be sure to put the lens down with the lens mount side facing upward to protect from damage to the area around the lens mount after removal.

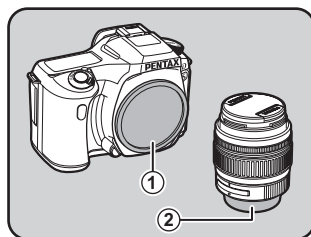

3 Align the red dots on the camera and the lens, and secure by turning the lens clockwise until it clicks.

After attaching, check that the lens is secured. Also check that the red dots of the lens are on top and attachment portion does not move sideways.

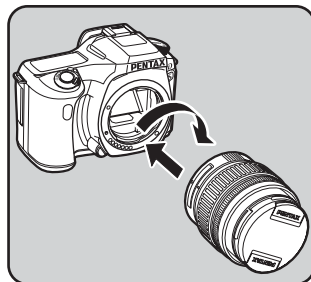

4 Remove the front lens cap by pushing the indicated portions inward.

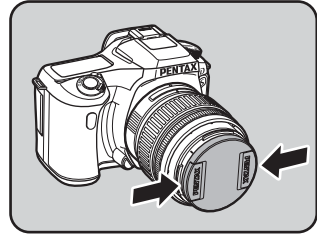

To detach the lens, hold down the lens unlock button (③) and turn the lens counterclockwise.

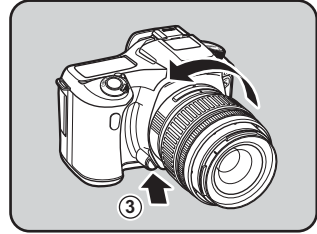

- The body mount cover (①) is a cover to prevent scratches and block dust when shipped. “Body Mount Cap K” is sold separately and has a lock function.
- We assume no responsibility nor liability for accidents, damages and malfunctions resulting from the use of lenses made by other manufacturers.
- The camera body and lens mount incorporate lens information contacts and an AF coupler. Dirt, dust, or corrosion may damage the electrical system. Clean the contacts with a soft dry cloth.

Adjust the viewfinder to suit your eyesight. If it is difficult to see the viewfinder image clearly, slide the diopter adjustment lever sideways.

You can slide the diopter from -2.5m^{-1} to $+1.5\text{m}^{-1}$.

- 1 Look through the viewfinder and point the camera at a well-lit scene. Slide the diopter adjustment lever left or right.**

Adjust the lever until the focus point AF frame in the viewfinder is focused.

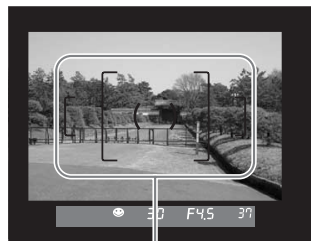
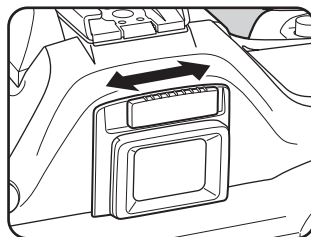

Focus Point AF Frame



Eye cup is attached to the viewfinder portion when camera leaves the factory. Diopter adjustment is available with the eye cup attached. However, adjustment is easier with the eye cup removed as shown above. To remove the eye cup, pull upward and remove as shown on the right.

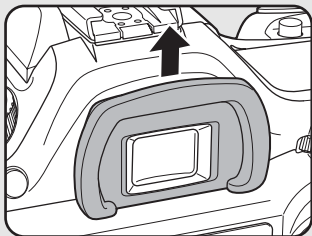

3 Basic Operations

This chapter explains basic operations for shooting by setting mode dial to Picture mode (Auto Picture or Normal mode - Flash OFF mode) to ensure successful capturing.

For information about advanced functions and settings for taking pictures, refer to chapter 4 and onward.

Basic Shooting Operation	42
Selecting the Appropriate Capturing Mode for Scenes	47
Using the Zoom Lens	48
Using the Built-in Flash	49
Other Shooting Modes	53
Playing Back Still Pictures	63
Connecting the Camera to AV Equipment	70
Processing Images with Filters	71
Deleting Images	73
Setting the Printing Service (DPOF)	79
Printing Using PictBridge	83

Holding the Camera

How you hold the camera is important when taking pictures.

- Hold the camera firmly with both hands.
- Press the shutter release button gently when taking a picture.

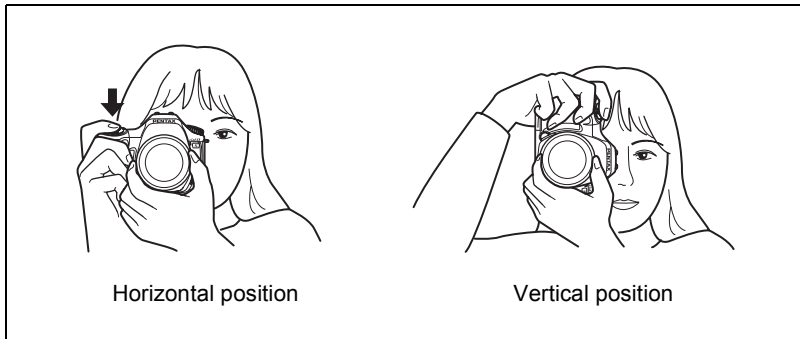

3

Basic Operations



- To reduce camera shake, support your body or the camera on a solid object such as a table, tree, or wall.
- Although there are individual differences among photographers, the shutter speed for a handheld camera is generally $1/(\text{focus length} \times 1.5)$. For example, it is $1/75$ of a second for a focus length of 50 mm and $1/150$ of a second for 100mm. A tripod should be used for shutter speeds slower than this.
- When using a telephoto lens, a tripod that is heavier than the total weight of the camera and lens is recommended to avoid camera shake.

Letting the Camera Choose the Optimal Settings

Capturing method where the camera automatically selects optimal settings by scene when shutter release button is pressed is explained.

1 Set the mode dial to **AUTO PICT**.

The camera will select the optimal capturing mode for the subject.

☞ Selecting the Appropriate Capturing Mode for Scenes (p.47)

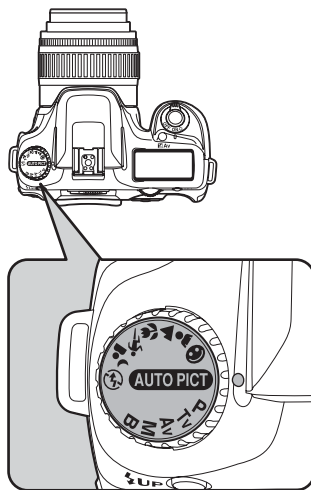

2 Set the focus mode lever to **AF**.

Autofocus mode is set. (p.118)

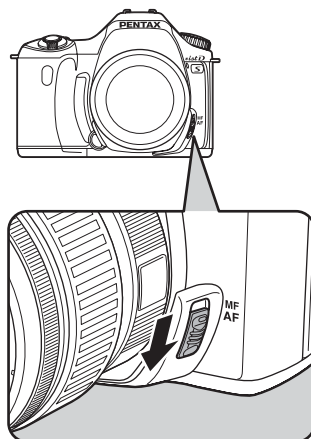

3 Turn the zoom ring to determine the size of the subject.

Determine the size of the subject.

☞ Using the Zoom Lens (p.48)

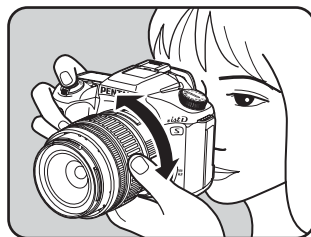

4 Position the subject inside the autofocus frame and press the shutter release button halfway.

The autofocus system operates. The focus indicator ● appears in the viewfinder when the subject is in focus.

The flash pops up automatically when necessary. (Manually lift the flash when Flash mode is not set to [Auto].)

☞ OPERATING THE SHUTTER RELEASE BUTTON (p.45)

☞ Hard-to-Autofocus Subjects (p.46)

☞ Using the Built-in Flash (p.49)

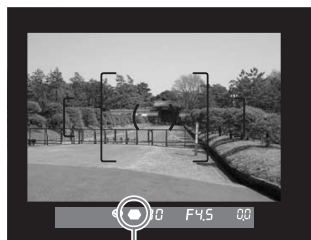

Focus indicator

5 Press the shutter release button fully.



The picture is taken.



6 Review captured images on the LCD monitor.

Image displays for one second on the LCD monitor after capturing (Instant Review.)

You can delete the image during Instant Review by pressing the  button.

-  Setting the Display Time (p.170)
-  Deleting Images (p.73)
-  Displaying Hot Spot Warning (p.160)

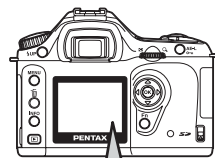

OPERATING THE SHUTTER RELEASE BUTTON

The shutter release button has two positions.

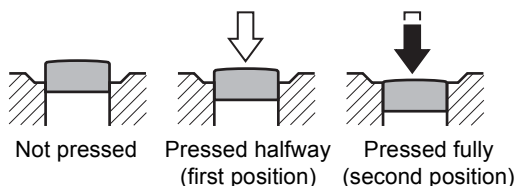

Pressing it down halfway (first position) turns on the viewfinder and LCD display indicators displays and the autofocus system operates. Pressing it fully (second position) takes the picture.



- Press the shutter release button gently when taking a picture to prevent camera shake.
- Practice pressing the shutter release button halfway to learn where the first position is.
- The viewfinder indicators stay on while shutter release button is pressed. The indications stay on for about 10 seconds (default setting) after the button is released. (p.20)

Hard-to-Autofocus Subjects

The autofocus mechanism is not perfect. Focusing may be difficult when capturing under the following conditions (a to f below). These also apply to manual focusing using the focus indicator  in the viewfinder.

If the subject cannot be focused automatically, set the focus mode lever to **MF** and use the manual focus mode to focus on the subject with the aid of the matte field in the viewfinder. (p.122)

- (a) Extremely low-contrast subjects such as a white wall in the focus points range.
- (b) Subjects which do not reflect much light within the focus points range.
- (c) Fast moving objects.
- (d) Strongly reflected light or strong backlighting (bright background).
- (e) If vertical or horizontal line patterns appear within the focus points range.
- (f) Multiple subjects in the foreground and background within the focus points range.



Subject may not be focused even when  (focus indicator) is displayed when (f) above applies.

Selecting the Appropriate Capturing Mode for Scenes

The camera selects and set the optimum mode when **AUTO PICT** (Auto Picture) on the mode dial is set to the dial indicator.

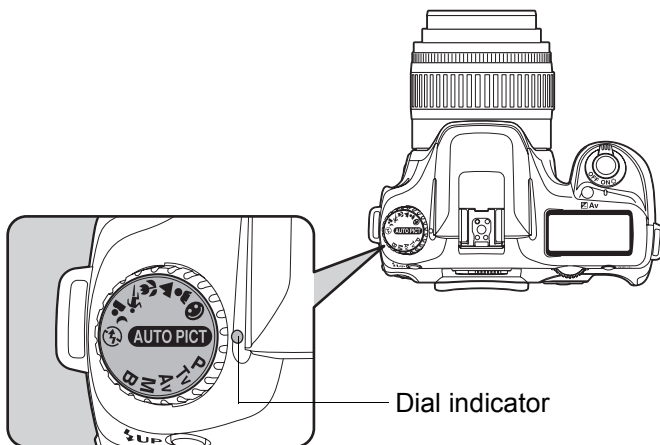

Select ☺ (Normal), 👤 (Portrait), ▲ (Landscape), 🌸 (Macro), 🏃 (Moving Object), 🌃 (Night Scene Portrait), ⚡ (Flash OFF) with the mode dial if desired image is not captured.

The modes are as follows.

AUTO PICT (Auto Picture)	Selects automatically from Normal, Portrait, Landscape, Macro, and Moving Object modes.
☺ (Normal)	The basic picture-taking mode.
👤 (Portrait)	Optimal for capturing portraits.
▲ (Landscape)	Deepens the focus range, emphasizes contour and saturation of trees and the sky produces a bright image.
🌸 (Macro)	Lets you take vibrant pictures of flowers up close.
🏃 (Moving Object)	Lets you take sharp pictures of a quickly moving subject, such as at a sporting event.
🌃 (Night Scene Portrait)	Lets you capture people against a night view or nightscape.
⚡ (Flash OFF)	The built-in flash is deactivated. Other settings are the same as Normal (☺).

Using the Zoom Lens

Enlarge (telephoto) or capture a wider area (wide angle) with a zoom lens. Adjust it to the desired size and take the picture.

1 Turn the zoom ring to the right or left.

Turn the zoom ring clockwise for telephoto and counterclockwise for wide angle.

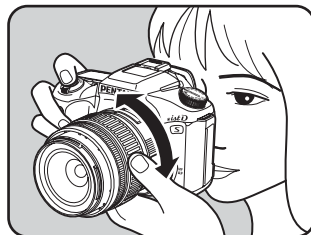

3

Basic Operations



- The smaller the number of the displayed focal length, the wider the angle. The larger the number, the more magnified the image appears.
- Power Zoom functions (Image Size Tracking, Zoom Clip, and Auto Zoom Effect) are not compatible with this camera.

Wide Angle

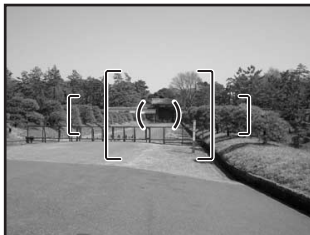

Telephoto

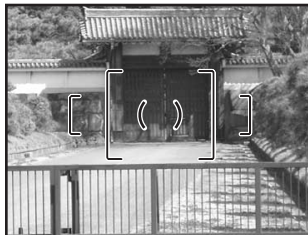

Using the Built-in Flash

Use the following procedures to take a picture in low light or backlit conditions or when you want to manually use the built-in flash.

The built-in flash is optimum at about 0.7 m to 4 m. Exposure will not be properly controlled and vignetting may occur when used at a distance closer than 0.7 m. (This distance varies slightly depending on the lens being used and set sensitivity. (p.149))

Compatibility of built-in flash and lens

Vignetting (surrounding portions are blackened due to a lack of light) may occur depending on the lens being used and the capture conditions. We recommend taking a test shot to confirm this.

☞ DA, D FA , FA J, FA and F Lens Compatibility with the Built-in Flash (p.151)



- When using the built-in flash, remove the lens hood before shooting.
- The built-in flash fully discharges when pre A lenses are used.

Auto discharge	Camera automatically determines surrounding light and built-in flash pops up and discharges automatically when necessary. (Flash does not discharge even if it is popped up when not necessary.)
Manual discharge	Discharges flash manually. Flash discharges when popped up, does not discharge when retracted.
Auto flash+Redeye reduce	Light a red-eye reduction light before automatic flash.
Manual flash+Redeye reduce	Discharges flash manually. Light a red-eye reduction light before manual flash.



- In Flash OFF mode, flash does not discharge even if settings are changed. The set Flash mode is retained.
- Manual discharge mode (Flash ON) is used regardless of flash mode settings if the button is pressed to pop up the flash manually.

Selecting Flash Mode

1 Press the Fn button.

The Fn menu appears.

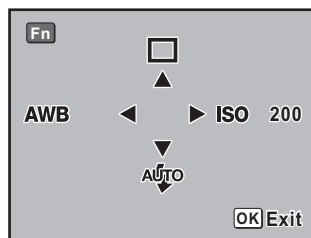

2 Press the four-way controller (▼).

The flash options screen appears.

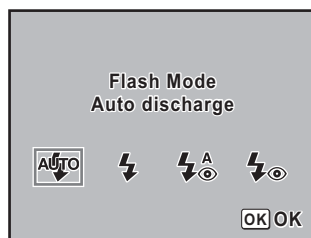

3 Use the four-way controller (◀▶) to choose a flash mode.

4 Press the OK button twice.

The camera is ready to take a picture.

Using Auto Discharge , (Automatic Flash Popup)

1 Set the mode dial to , , , , or .

2 Press the shutter release button halfway.

The built-in flash pops up if necessary and begins charging. When the flash is fully charged,  appears in the LCD monitor, LCD panel and viewfinder. (p.17, p.20, p.22)

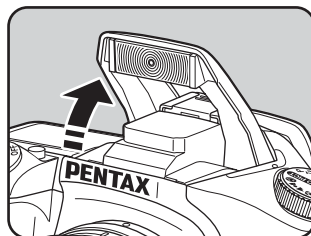



Switch between Auto discharge mode and Manual discharge mode (Flash ON) by pressing the **⚡UP** button while the built-in flash is popped up. If Auto discharge is set, **⚡AUTO** appears on the LCD panel.

3 Press the shutter release button fully.

The picture is taken.

4 Push down on the portion indicated in the illustration to retract the flash.

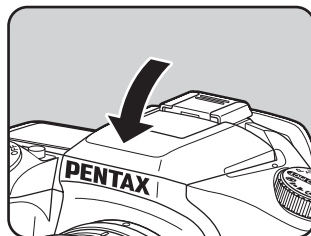

Using Manual Discharge (Flash ON) ⚡, ⚡👁

1 Press the **⚡UP** button.

The built-in flash pops up and begins charging. Manual discharge mode (Flash ON) is used regardless of flash mode settings. When discharge is fully charged, **⚡** appears in the LCD monitor, LCD panel and viewfinder. (p.17, p.20, p.22)

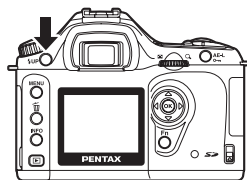

Switch between Auto discharge mode and Manual discharge mode by pressing the **⚡UP** button while the built-in flash is popped up when shooting mode is set to **AUTO PICT**, **☺**, **👤**, **▲**, **🌸**, **🦋**, or **👦**.

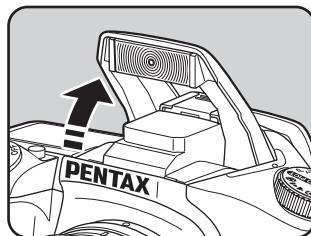

2 Press the shutter release button fully.

The flash discharges and the picture is taken.



3 Push the flash down retract.

Using Red-eye Reduction Flash

Red-eye is the phenomenon where eyes look reddish in photographs taken in dark environments with a flash. This is caused by the reflection of the electronic flash in the retina of the eye. Red-eye occurs because pupils are dilated in dark environments.

This phenomenon cannot be averted but the following measures can be used to combat it.

- Brighten the surroundings when shooting.
- Set to wide angle and shoot from closer if a zoom lens is in use.
- Use the red-eye reduction built-in flash.
- Position the flash as far away from the camera as possible when using an external flash.

The red-eye reduction function on this camera reduces red-eye by discharging the flash twice. With the red-eye reduction function, the pre-flash is discharged just before the shutter is released. This reduces pupil dilation. The main flash is then discharged while the pupils are smaller, reducing the red-eye effect. To use the red-eye reduction function, set  (Red-eye reduction auto flash) in Picture mode or  (Red-eye reduction manual flash) in other modes for Flash mode.

Daylight-Sync Shooting

In daylight conditions, the flash will eliminate shadows when a portrait picture is taken with a person's face cast in shadow. Use of the flash in this way is called Daylight-Sync Shooting. Flash is discharged manually when shooting with Daylight-Sync Shooting.

● Taking pictures (Auto Picture)

- 1 Confirm that the flash mode is set to  (Manual discharge). (p.51)
- 2 Confirm that the flash is fully charged.
- 3 Take the picture.



The picture may be over-exposed if the background is too bright.



Without Daylight-Sync



With Daylight-Sync

Continuous Shooting

Pictures can be taken continuously while the shutter release button is held down.

- 1 Press the Fn button.

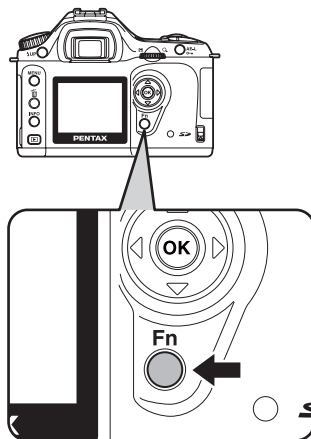

The Fn menu appears.

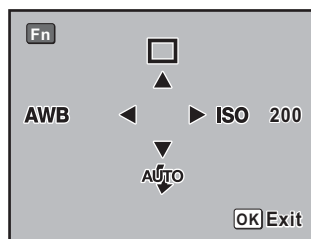

- 2** Press the four-way controller (▲).

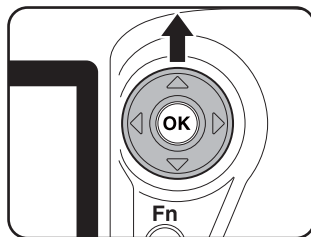

The Drive Mode options screen appears.

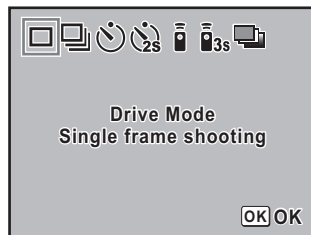

- 3** Use the four-way controller (◀▶) to select .

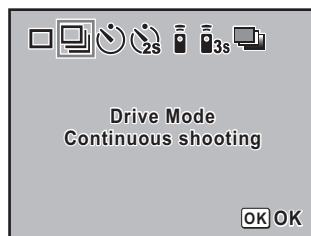

- 4** Press the OK button twice.

The camera is ready to take pictures.

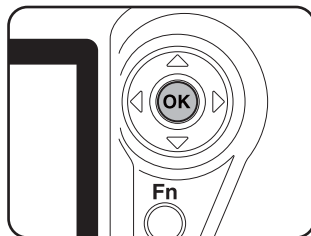

- 5** Press the shutter release button halfway.

The autofocus system operates. The focus indicator ● appears in the viewfinder when the subject is in focus.



Set [2 (No. cnt shtng rcd im)] in [Recordable image No.] of the [C Custom] menu. The number of continuously recordable images (buffer space) appears when shutter is pressed halfway. (p.100)

6 Press the shutter release button fully.

Pictures are taken continuously while the shutter release button is fully pressed. Take your finger off of the shutter release button to stop.

Continuous shooting settings are retained when the power is turned off. Display the Fn menu again and set to □ (Single frame shooting) to stop Continuous shooting.



- The focus is adjusted each time the shutter is released if the focus mode lever is set to **AF**.
- When the picture mode is (Moving Object) and **AF** is set, continuous autofocus mode is set and the focus is adjusted for each shot. Note that the shutter will release even if the focusing is not complete.
- The shutter cannot be released until charging is complete when using the built-in flash. Use a custom function to enable shutter release before the built-in flash is ready. (p.147)

Self-Timer Shooting

This camera has two types of self-timers: and .

	Shutter will be released after about 12 seconds. Use the self-timer mode to include the photographer in the picture.
	A mirror pops up immediately after shutter release button is pressed. Shutter is released after about two seconds. Use this mode to avoid camera shake when the shutter release button is pressed.

1 Mount the camera to a tripod.

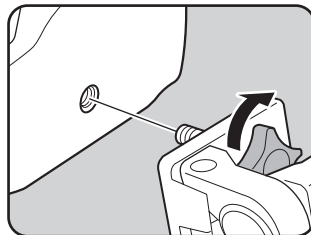

2 Press the Fn button.

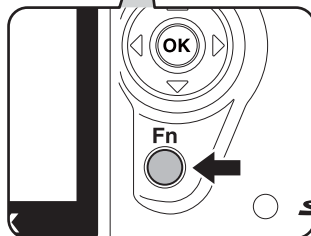
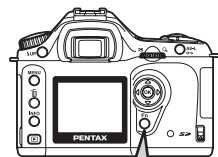

The Fn menu appears.

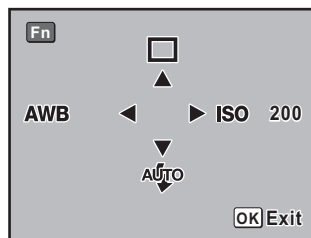

3 Press the four-way controller (▲).

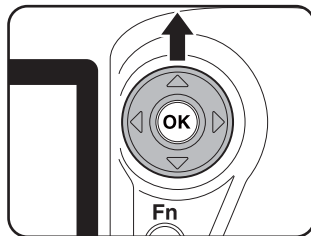

The Drive Mode options screen appears.

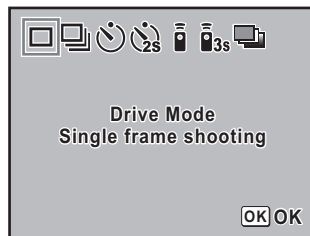

- 4** Use the four-way controller (◀▶) to select or .



- 5** Press the **OK** button twice.

The camera is ready to take pictures.

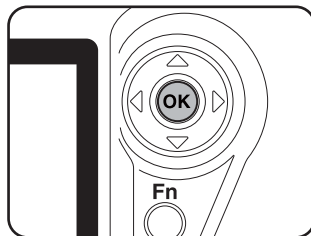

- 6** Confirm in the finder that the subject you wish to shoot is in the display and press the shutter release button halfway.

The focus indicator appears when the subject is in focus.



7 Press the shutter release button fully.

For , the self-timer lamp starts blinking slowly and blinks rapidly two seconds before the shutter is released. The beep is heard and the rate increases. The shutter will be released about 12 seconds after the shutter release button is pressed fully.

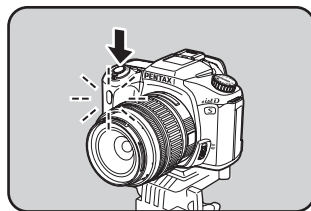

For , the shutter will be released about two seconds after the shutter release button is pressed fully.

 The beep can be turned off. “Turning the Beep On and Off” (p.163)



- Exposure may be affected if light enters the viewfinder. Attach the provided viewfinder cap or use the AE lock function (p.142). (Ignore the light entering the viewfinder when the exposure mode is set to **M** (Manual) (p.138).)
- Remove the Eyecup FL by pulling one side upward when using accessories such as the viewfinder cap.

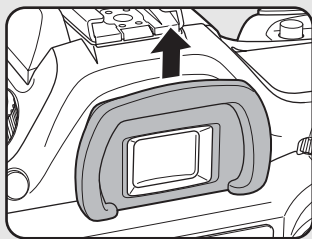

Removing the Eyecup FL

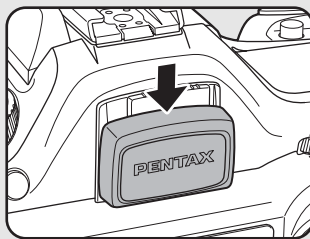

Attaching the Viewfinder cap

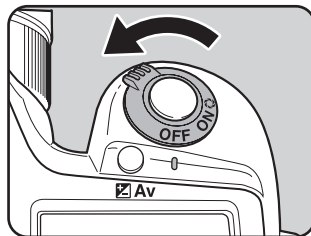

8 Turn the camera off after shooting.

The next time the power is turned on, self-timer shooting is canceled and returns to single frame shooting.



Remote Control Shooting (Remote Control F: Sold Separately)

The shutter can be released with the optional remote control unit. You can select from  (remote control) and  (three-second delay) for remote control shooting.

	The shutter will be released immediately after the shutter release button on the remote control unit is pressed.
	The shutter will be released three seconds after the shutter release button on the remote control unit is pressed.

1 Mount the camera to a tripod.

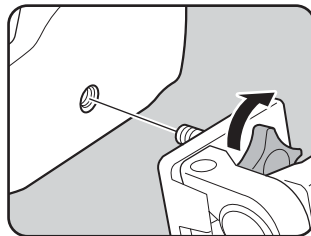

2 Press the Fn button.

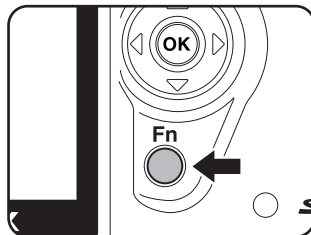

The Fn menu appears.

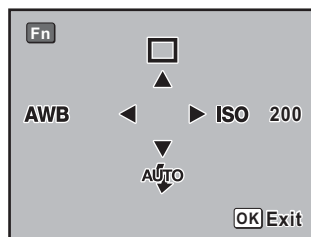

3 Press the four-way controller (▲).

The Drive Mode options screen appears.

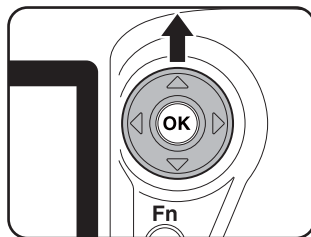

4 Use the four-way controller (◀▶) to select \bar{i} or \bar{i}_{SS} .

The self-timer lamp will blink to let you know that the camera is in remote control wait status.



5 Press the OK button twice.

The camera is ready to take pictures.

6 Press the shutter release button halfway.

The autofocus system operates. The focus indicator ● appears in the viewfinder when the subject is in focus.



- You cannot focus with the remote control unit in default settings. Focus on the subject first before operating with the remote control. You can set [AF in remote control] to [On] in the custom function. (p.100)
- When using the Remote Control Unit, flash does not fire automatically even when set to \overrightarrow{A} (Auto discharge). Pop up the flash manually beforehand. (p.51)

7 Point the remote control unit towards the front of the camera and press the shutter release button on the remote control.

The operating distance of the remote control unit is about 5 m from the front of the camera. The shutter will be released immediately or approximately three seconds after the shutter release button on the remote control unit is pressed.

When the picture is taken, the self-timer lamp lights for two seconds and will then resume blinking.

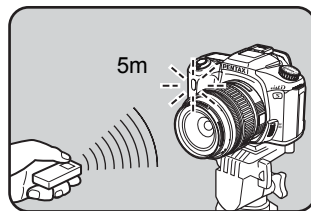

- Exposure may be affected if light enters the viewfinder. Attach the provided viewfinder cap or use the AE lock function (p.142). (Ignore the light entering the viewfinder when the exposure mode is set to **M** (manual) (p.138).)
- Remove the Eyecup FL by pulling one side upward when using accessories such as the viewfinder cap.

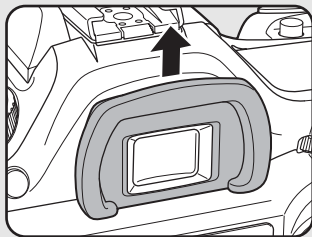

Removing the Eyecup FL

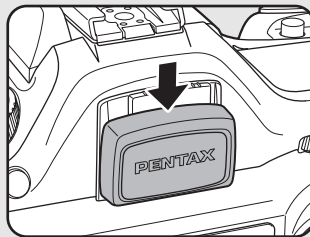

Attaching the Viewfinder cap

- Turn the power off to stop the remote control operation after it has been activated.
- The remote control may not operate in backlit conditions.
- The remote control does not work while the flash is being charged.
- When using the built-in flash, raise the flash into position first.
- The camera automatically returns to single frame shooting after the remote control shooting mode is left unused for five minutes.
- The remote control unit battery can send a remote control signal about 30,000 times. Contact PENTAX service center to exchange the battery. (This will involve a fee.)

Using Mirror Lock Up Function to Prevent Camera Shake

Use the Mirror Lock Up function if camera shake is evident even when Cable Switch (optional) or Remote Control Unit (optional) is used. When shutter release button is pressed, mirror pops up and shutter is released two seconds if 2 sec. Self-Timer is used. Avoid camera shake when mirror pops up with this method.

Follow the procedure below to take a picture with the mirror lock up.

- 1 Mount the camera to a tripod.
- 2 Use the **Fn** button and the four-way controller (▲) to select [ (2 sec. Self-Timer)]. (p.55)
- 3 Focus on the subject.
- 4 Press the shutter release button fully.

The mirror pops up and the picture is taken two seconds later. AE lock is enabled with the exposure value immediately before the mirror goes up.

Playing Back Images

You can play back captured still pictures with the camera.



Use the included PENTAX PHOTO Browser 2.0 software to play back using a PC. Refer to the "PENTAX PHOTO Browser 2.0/PENTAX PHOTO Laboratory 2.0 Operating Manual" for details.

1 Press the button after taking a picture.

The most recently captured image (image with the largest file number) is displayed on the LCD monitor.

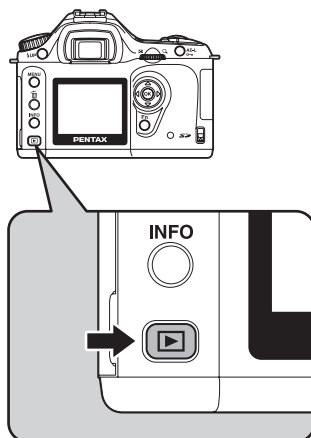

2 Press the four-way controller (◀▶).

- ◀ : The previous image appears.
- ▶ : The next image appears.

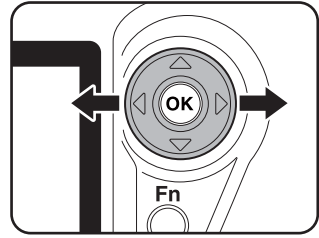

Rotating Images

You can rotate images 90° counterclockwise at a time. Make images shot vertically easier to view.



1 Press the button after taking a picture.

The most recently captured image (image with the largest file number) is displayed on the LCD monitor.

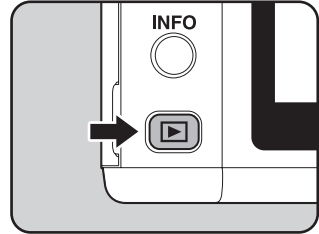

2 Press the four-way controller (▼).

The image is rotated 90° counterclockwise each time the button is pressed.

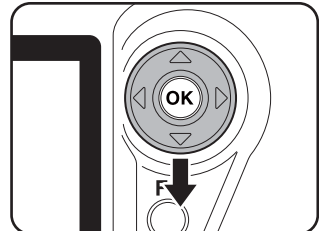

3 Press the OK button.

Image rotation information is saved.

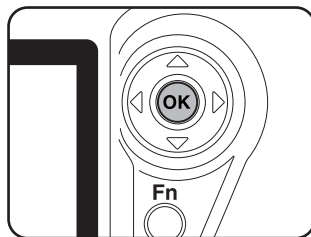

Enlarging Playback Images

You can magnify images up to 12 times when displaying.

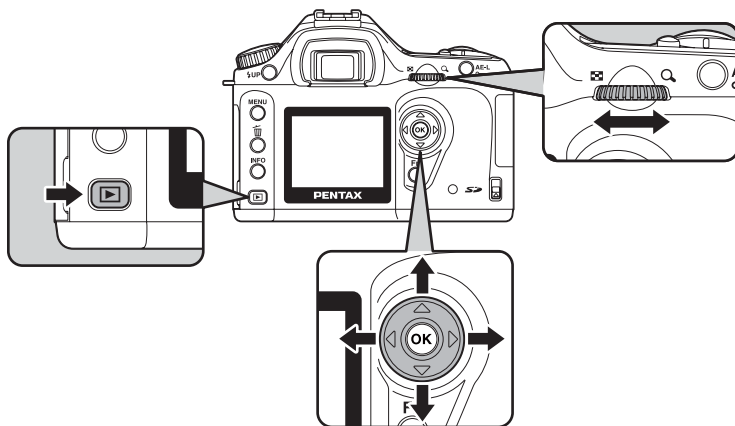

1 Press the button and use the four-way controller (◀▶) to select an image.





The most recently captured image (image with the largest file number) is displayed first on the LCD monitor.



2 Turn the e-dial to the right (toward Q).

Image enlarges at each calibration and can be enlarged to 12 times the original. Turn to the left (toward ) to return.

Press the **OK** button to return to the original size.

Press four-way controller (   ) in zoom display to change the display area.



3



The first calibration on the e-dial is 1.2 times. You can change this in [Mag to Strt Zm Plybk] in [C Custom] menu. (p.101)

Nine-Image Display

You can display nine images on the LCD monitor at the same time.

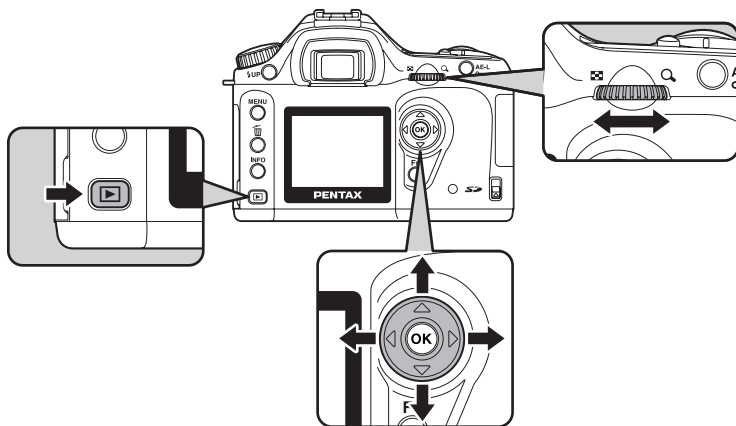





1 Press the button.

The most recently captured image (image with the largest file number) is displayed on the LCD monitor.



2 Turn the e-dial to the left (toward).

Up to nine thumbnail images will be displayed at once. Press the four-way controller (   ) to select an image. A scroll bar appears at the right of the screen. With an image selected in the bottom row, pressing the four-way controller () displays the next nine images.

[?] appears for an image that cannot be displayed.

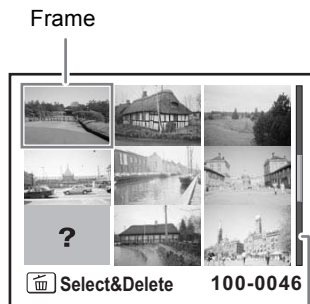

Scroll bar

3 Turn the e-dial to the right (towards) or press the OK button.

A full screen display of the selected image appears.



Slideshow

You can play back all images recorded on your SD Memory Card successively. To start continuous playback, use the menu screen displayed on the LCD monitor.

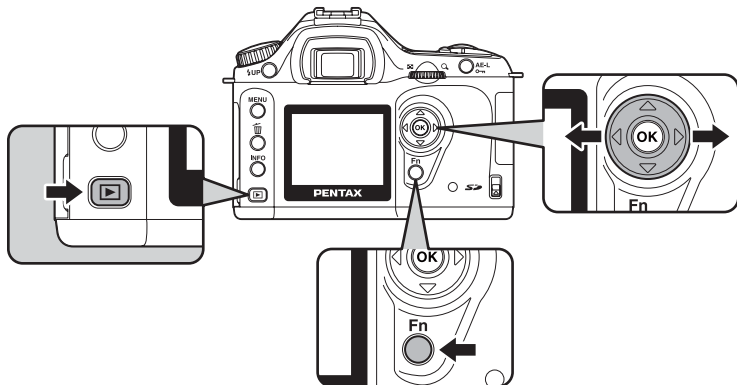

- 1 Press the  button and use the four-way controller ( ) to select an image to be displayed first.

The most recently captured image (image with the largest file number) is displayed first on the LCD monitor.



- 2 Press the Fn button.

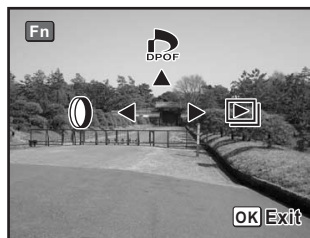

The Fn menu appears.





3 Press the four-way controller (▶).

Start screen is displayed and slideshow begins.

Press any button to end slideshow.

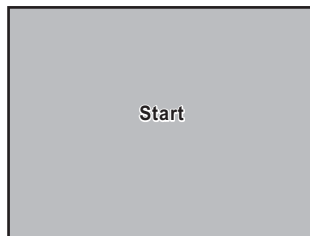
Press the shutter release button or the  button, slide the main switch to  (preview) or turn the mode dial to change to Capture mode.



Set the display time for slideshow in the [ Playback] menu. Alternatively, start the slideshow from the [ Playback] menu. (p.161)

Connecting the Camera to AV Equipment

By using the video cable, you can play back images using a TV or other device with a video IN jack as your monitor. Make sure that both the TV and the camera are turned off before connecting the cable.

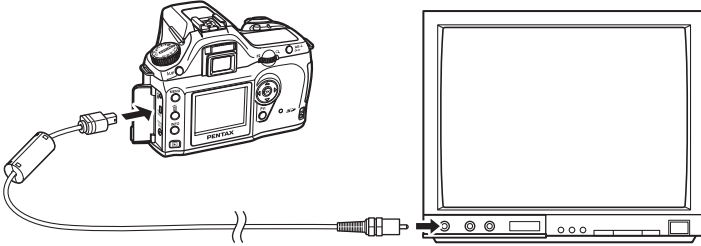

3

Basic Operations

- 1** Connect the video cable to the USB/Video terminal on the camera.
- 2** Connect the other end of the video cable to the video IN jack on the TV.
- 3** Turn the TV and camera on.



- If you intend to use the camera continuously for a long period, use of the AC adapter (optional) is recommended. (p.28)
- Refer to the operating manual for the TV or AV device to which the camera is connected.

You can edit shot images using digital filters. Processed images are saved under a different name.



- RAW images cannot be processed using the digital filter.
- Additionally, set digital filters from the [▶ Playback] menu.

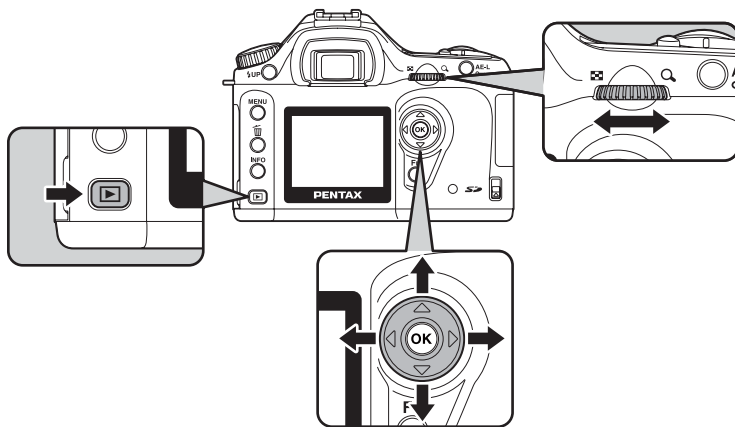

Digital Filter

B&W	Convert to a black and white image.
Sepia	Add a vintage touch to photos by converting them to sepia color.
Soft	Create a soft image by lightly fading the entire image.
Slim	Change the horizontal and vertical ratio of images. Adjust height or width up to two times the original size.

1 Press the Fn button in Playback mode.

The Fn menu appears.

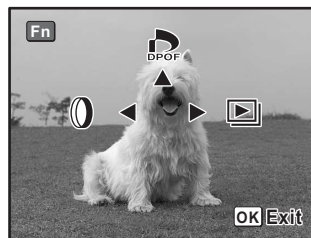

2 Press the four-way controller (◀).

The screen for selecting the filter appears.

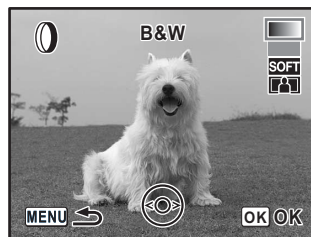

3 Use the four-way controller (◀▶) to select an image.

4 Use the four-way controller (▲▼) to select a filter.

Select a filter and preview the effects on the image. Proceed to step 6 if [B&W], [Sepia] or [Soft] is selected.

5 Adjust slimness with e-dial if slim filter is selected.

Turn counterclockwise for wider and clockwise for slimmer.

Use the four-way controller (◀▶) to select an image. The image appears in the set slimness.

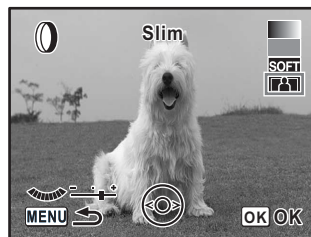

6 Press the OK button.

The save confirmation screen appears.

7 Use the four-way controller (▲) to select [Save as].

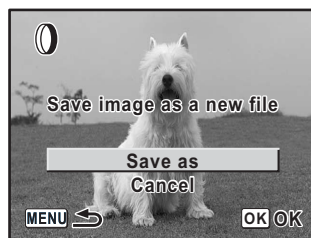

8 Press the OK button.

The filtered image is saved under a different name.

Deleting a Single Image

You can delete one image at a time.



- Deleted images cannot be restored.
- Protected images cannot be deleted.

- 1** Press the button and use the four-way controller (◀▶) to select an image to delete.



- 2** Press the button.
The Delete screen appears.

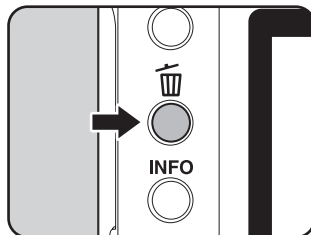

- 3** Use the four-way controller (▲) to select [Delete].

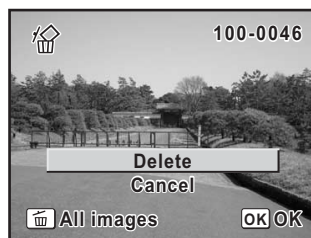

- 4** Press the **OK** button.
The image is deleted.

Deleting All Images

You can delete all saved images at once.



- Deleted images cannot be restored.
- Protected images cannot be deleted.

1

Press the  button.

2

Press the  button twice.

The Delete All screen appears.

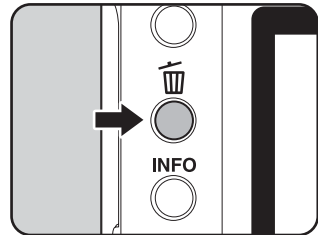
**3**

Press the four-way controller () to select [Delete All] and press the OK button.

All images are deleted.

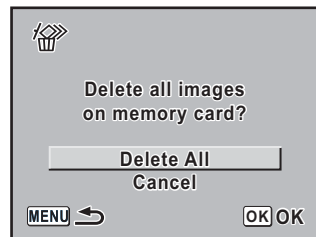

Deleting Selected Images (from Nine-Image Display)

You can delete multiple images from the nine-image display at once.



- Deleted images cannot be restored.
- Protected images cannot be deleted.
- Only files in the same folder can be selected at once.

1 Press the button.

The most recently captured image (image with the largest file number) is displayed first on the LCD monitor.



2 Turn the e-dial to the left (toward).

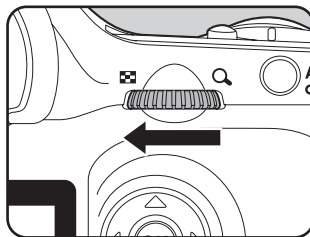

Nine thumbnail images appear.



3 Press the button.

appears above the images.

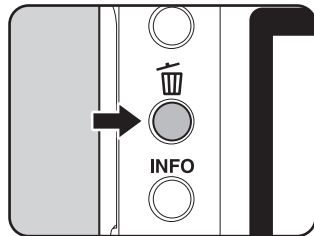

4 Use the four-way controller (▲▼◀▶) to move to the images to delete and press the OK button.

Image is selected and appears.

Press **Fn** button to select all images.

(The selection of images may take time to complete depending on the number of images.)

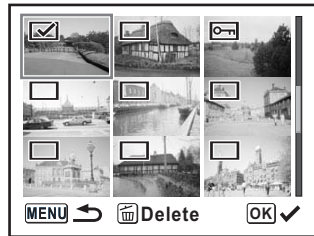

5 Press the button.

The Delete confirmation screen appears.

6 Use the four-way controller (▲) to select [Select&Delete].

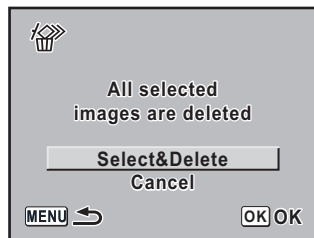

7 Press the OK button.

The selected images are deleted.

Protecting Images from Deletion (Protect)

You can protect images from being accidentally erased.



Even protected images are deleted if the SD Memory Card is formatted.

- 1 Press the button and use the four-way controller () to select an image.

The most recently captured images (image with the largest file number) are displayed first on the LCD monitor.



- 2 Press the button.

The Protect screen appears.

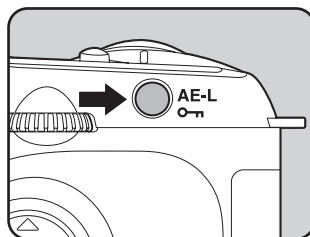

- 3 Use the four-way controller () to select [Protect].

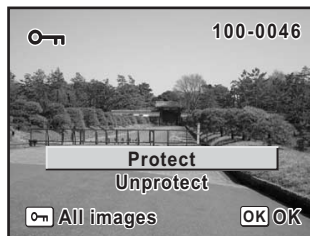



- 4 Press the **OK** button.

The selected image is protected.



- Select [Unprotect] in step 3 to cancel the Protect setting.
- The symbol is displayed when playing back protected images. (p.19)

Protecting All Images

- 1 Press the  button.
- 2 Press the  button twice.

The Protect all images screen appears.

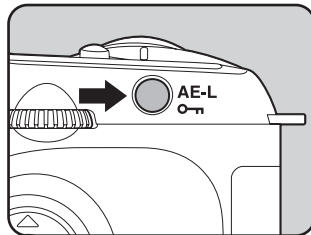

3

Basic Operations

- 3 Press the four-way controller () to select [Protect] and press the OK button.

All images saved in the SD Memory Card are protected.

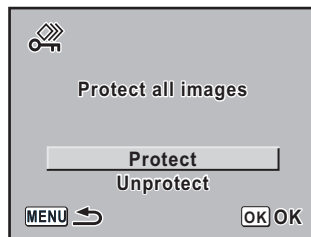

Select [Unprotect] in step 3 to cancel the Protect setting on all of the images.

You can order conventional photograph prints by taking the SD Memory Card with recorded images to a store for a printing service.

DPOF (Digital Print Order Format) settings allow you to specify the number of copies or to imprint the date.



DPOF settings cannot be applied to RAW images.

Printing Single Images

Set the following items for each image.

Copies	Choose the number of copies. You can print up to 99 copies.
Date	Specify whether you want the date inserted on the print or not.

1 Press the button and use the four-way controller () to select an image.

2 Press the Fn button.

The Fn menu appears.

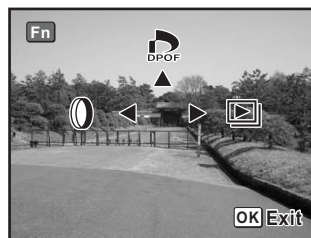

3 Press the four-way controller () .

The DPOF screen appears.

If DPOF settings have already been made for an image, the previous number of prints and date setting ((on) or (off)) will be displayed.

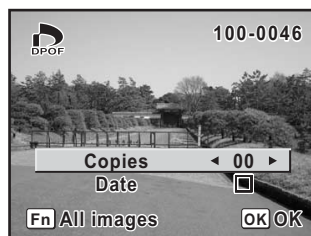

- 4** Use the four-way controller (◀▶) to choose the number of copies and press the four-way controller (▼).

The frame moves to [Date].

- 5** Use the four-way controller (◀▶) to choose whether to insert the date (☑) or not (☐).

- ☑ : The date will be imprinted.
 ☐ : The date will not be imprinted.

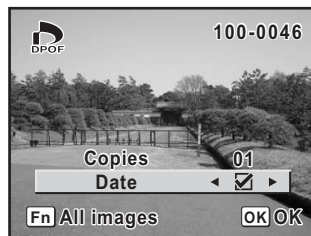

- 6** Press the **OK** button.

The DPOF settings are saved and the camera returns to playback status.



To cancel DPOF settings, set the number of copies to [00] in Step 3 and press the **OK** button.



Depending on the printer or printing equipment at the photo processing lab, the date may not be imprinted on the pictures even if the DPOF setting was made.

Settings for All Images

3

Basic Operations

- 1** Press the **Fn** button in Playback mode.

The Fn menu appears.

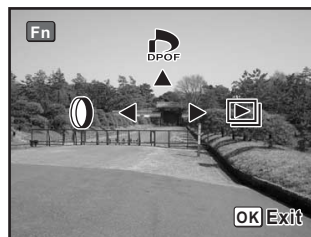

- 2** Press the four-way controller (**▲**).

The DPOF screen appears.

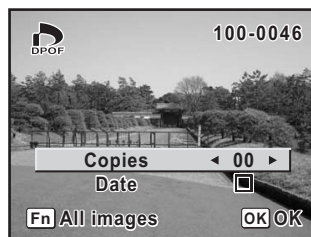

- 3** Press the **Fn** button.

The screen for making DPOF settings for all images appears.

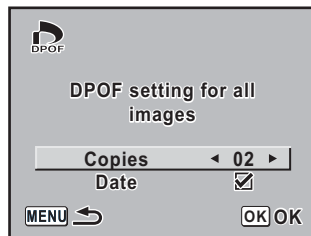

- 4** Use the four-way controller (**◀ ▶**) to choose the number of copies and whether to insert the date () or not (.

Refer to Steps 4 and 5 in "Printing Single Images" (p.80) for details of how to make the settings.

5 Press the OK button.

The DPOF settings for all the images are saved and the camera returns to playback status.



The number of copies specified in settings for all images applies to all the images. Before printing, check that the number is correct.



Settings for single images are canceled when settings are made for all images.

This function lets you print images directly from the camera without using a PC (direct printing).

Connect the camera and PictBridge compatible printer with the included USB cable (I-USB17) to print directly.

Select the images you want to print, the number of copies and whether to insert the date or not on the camera after connecting to the printer.

Direct printing is performed in the following steps.

Set [Transfer Mode] on camera to [PictBridge] (p.84)



Connect the camera to the printer (p.85)



Set the printing options (p.79)

Print single images (p.86)

Print all images (p.88)

Print with DPOF settings (p.90)



Disconnect the camera from the printer (p.90)



- Use of the AC adapter is recommended when connecting the camera to a printer. The printer may not work properly or the image data may be lost if the battery runs out of power while the camera is connected to the printer.
- Do not disconnect the USB cable during data transfer.
- Depending on the type of printer, not all the settings made on the camera (such as print settings and DPOF settings) may be valid.
- A printing error may occur if the selected number of copies exceeds 500.
- You cannot use the camera to select multiple images for printing on a single sheet. Make the settings on the printer. For details, refer to the operating manual for your printer.
- See the “PENTAX PHOTO Browser 2.0/PENTAX PHOTO Laboratory 2.0 Operating Manual” when connecting to a PC.

Setting Transfer Modes

1 Press the MENU button.

The [📷 Rec. Mode] menu appears.

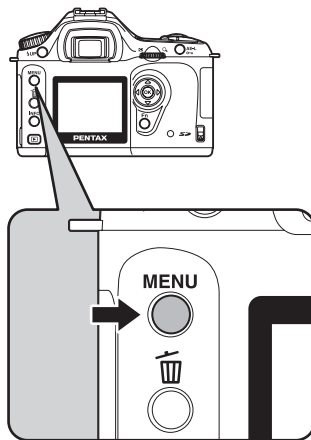

2 Use the four-way controller (◀▶) to select the [📷 Set-up] menu.

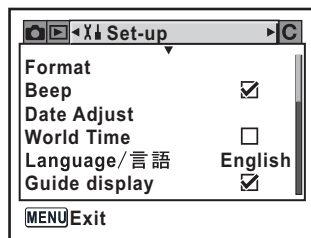

3 Use the four-way controller (▲▼) to select [Transfer Mode].

4 Press the four-way controller (▶).

A pop-up menu appears.

- 5** Use the four-way controller (▲▼) to select [PictBridge].

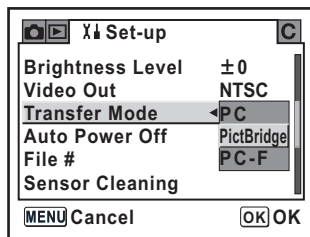

- 6** Press the **OK** button.

The setting is changed.

- 7** Press the **MENU** button.

Connecting the Camera to the Printer

- 1** Turn the camera off.

- 2** Connect the camera and PictBridge compatible printer using the USB cable supplied with the camera.

The PictBridge logo is displayed on PictBridge compatible printers.

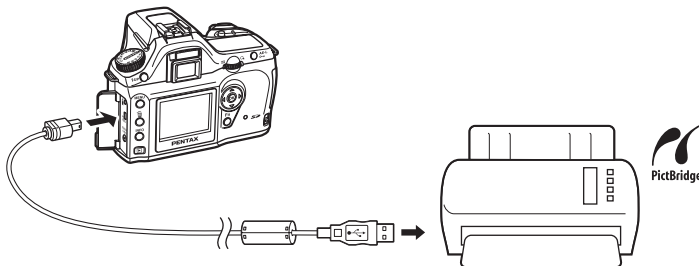

3 Turn the printer on.

4 After printer start-up is complete, turn the camera on.

The PictBridge menu appears.

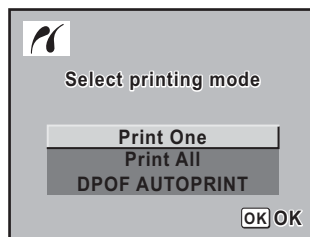

PictBridge menu is not displayed if [Transfer Mode] is set to [PC] or [PC-F].

Printing Single Images

1 Use the four-way controller (▲▼) to select [Print One] on the PictBridge menu.



2 Press the OK button.

The Print one screen appears.

3 Use the four-way controller (◀▶) to choose an image to print.



4 Use the four-way controller (▲▼) to choose the number of copies.

You can print up to 99 copies.

5 Use the Fn button to choose whether to insert the date (☑) or not (☐).

☑ : The date will be printed.

☐ : The date will not be printed.

6 Press the OK button.

The print settings confirmation screen appears.

Proceed to Step 12 to print the images by default, press the **OK** button.

To change the print settings, go to Step 7.

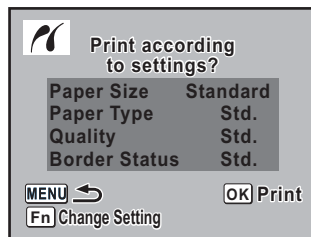

7 Press the Fn button.

The screen for changing print settings appears.

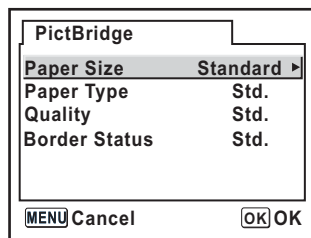

8 Select [Paper Size] and press the four-way controller (▶).

The Paper Size screen appears.

9 Use the four-way controller (▲▼◀▶) to choose the paper size.

You can only choose a size that is supported by your printer.

When the Paper Size is set to [Standard], images are printed according to the printer settings.

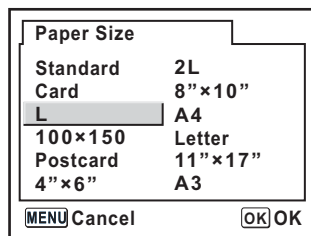

10 Press the **OK** button.

11 Repeat Steps 8 to 10 to set **[Paper Type]**, **[Quality]** and **[Border Status]**.

The print settings change screen appears after each item has been set. When the Paper Size is set to **[Standard]**, images are printed according to the printer settings.

Paper Type with more ★ support higher quality paper.

Quality with more ★ indicate higher print quality.

12 Press the **OK** button twice.

The image is printed according to the settings.

Press the **MENU** button to cancel printing.

Printing All Images

1 Use the four-way controller (▲▼) to select **[Print All]** on the **PictBridge** menu.

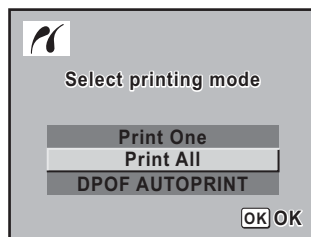

2 Press the **OK** button.

The Print all images screen appears.

3 Choose the number of copies and whether to insert the date or not and confirm the settings.

The number of copies and the date setting that you choose apply to all of the images.

Refer to “Printing Single Images” (p.86) for details on how to make the settings.

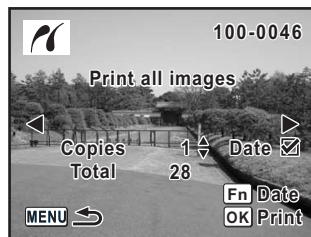

4 Press the OK button.

The print settings confirmation screen appears.

5 Press the OK button on the print settings confirmation screen.

All the images are printed according to the settings.

Press the **MENU** button to cancel printing.

Printing Images Using the DPOF Settings

1 Use the four-way controller (▲▼) to select [DPOF AUTOPRINT] on the PictBridge menu.

2 Press the **OK** button.

The Print w/DPOF settings screen appears. Use the four-way controller (◀▶) to check the image and print settings. Print settings are set with Print Service. (p.79)

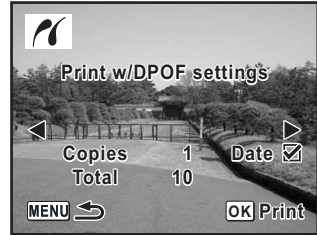

3 Press the **OK** button.

The print settings confirmation screen appears.

4 Press the **OK** button on the print settings confirmation screen.

The images are printed according to the settings.

Press the **MENU** button to cancel printing.

Disconnecting the Cable from the Printer

Disconnect the cable from the printer when you have finished printing.

1 Disconnect the **USB** cable from the camera.

2 Disconnect the **USB** cable from the printer.

4 Menu Reference

Explains the functions of **istDS* by buttons and menus.

Using the Button Functions	92
Using the Menu	96
Using the Fn Menu	102
Using the Mode Dial	104

Capture Mode

Functions of buttons used during shooting are noted.

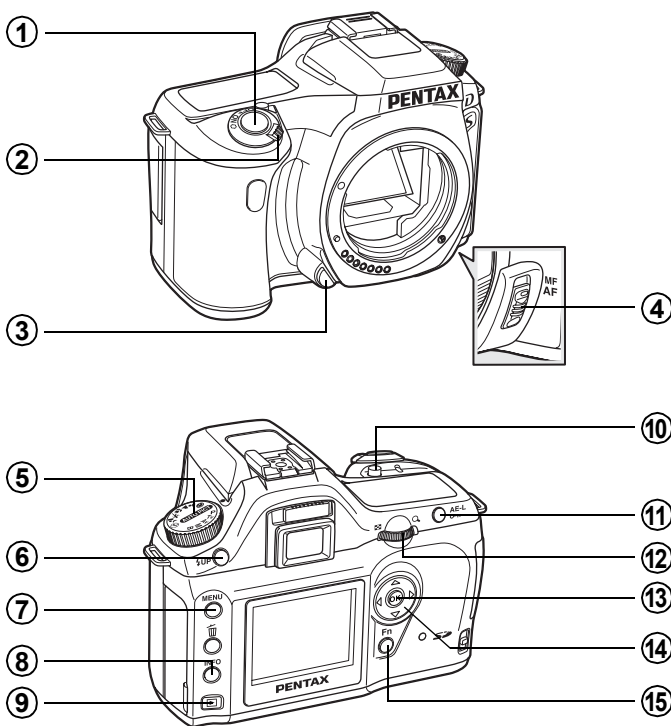

① Shutter release button

Press to capture images. (p.45)

② Main switch

Move to turn the power on/off (p.32) or confirm the depth of field (Preview) (p.129).

③ Lens unlock button

Press to detach lens. (p.37)

- ④ **Focus mode lever**
Switch between Autofocus mode (p.118) and Manual focus mode (p.121).
- ⑤ **Mode dial**
Changes the Shooting mode. (p.104)
- ⑥ **⚡UP button**
Press to pop up the built-in flash. (p.49)
- ⑦ **MENU button**
Displays the [📷 Rec. Mode] menu (p.98). Next, press the four-way controller (▶) to display [▶ Playback] menu (p.98), [⌘ Set-up] menu (p.99) and [C Custom] menu. (p.100)
- ⑧ **INFO button**
Press to show shooting information on the LCD monitor. (p.17)
- ⑨ **▶ button**
Switches to the Playback mode. (p.63)
- ⑩ **⊠Av button**
Press to set aperture and EV compensation values. (p.136, p.141)
- ⑪ **AE-L button**
Record the exposure before shooting. (p.142)
- ⑫ **e-dial**
Set shutter speed, aperture, and EV compensation values. (p.134, p.136, p.141)
- ⑬ **OK button**
Commit to the setting you selected in the menu.
- ⑭ **Four-way controller (▲▼◀▶)**
Use to move cursor or change items in menus and Fn menu.
- ⑮ **Fn button**
Press to display the Fn menu. Press the four-way controller (▲▼◀▶) to determine the following operation. (p.102)

Playback

Functions of buttons used during playback are noted.

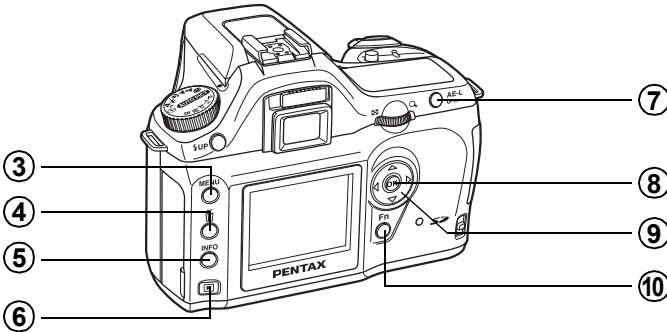
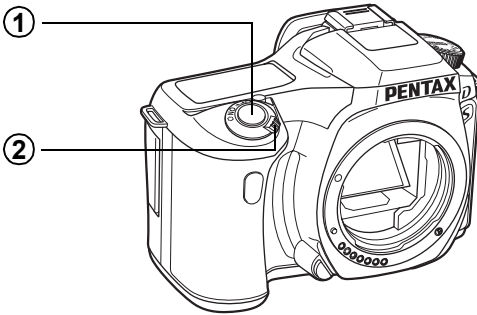

① Shutter release button

Press to switch to capture mode.

② Main switch

Move to turn the camera on and off (p.32)

③ MENU button

Press to display the [▶ Playback] menu (p.98). Next, press the four-way controller (◀▶) to display [X Set-up] menu (p.99), [C Custom] menu (p.100) and [Rec. Mode] menu (p.98).

④ button

Press to delete images. (p.73)

⑤ INFO button

Press to show shooting information on the LCD monitor. (p.18)

⑥  button

Press to switch to capture mode.

⑦  button

Press to protect images from being accidentally erased. (p.77)

⑧ OK button

Commit to the setting you selected in the menu or playback screen.

⑨ Four-way controller (▲▼◀▶)

Use to move cursor or change items in menus, Fn menu and playback screen.

⑩ Fn button

Press to display the Fn menu. Press the four-way controller (▲◀▶) to determine the following operation. (p.102)

How to Operate the Menu

This section explains operation methods for [📷 Rec. Mode] menu, [▶ Playback] menu, [⏏ Set-up] menu and [C Custom] menu.

Displaying the Menu screen

1 Press the MENU button in Capture mode.

The [📷 Rec. Mode] menu appears on the LCD monitor.

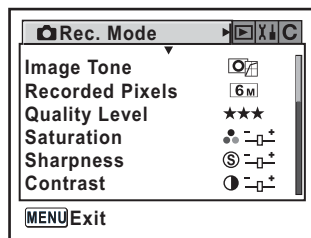
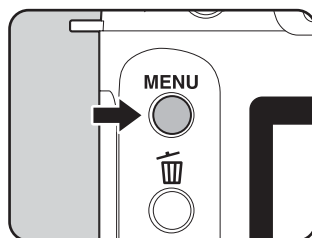

2 Press the four-way controller (▶).

[▶ Playback] menu, [⏏ Set-up] menu and [C Custom] menu appears each time the four-way controller is pressed.

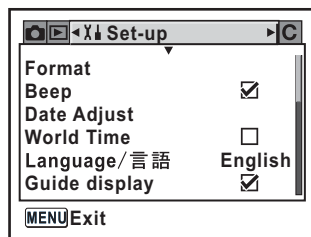

Select a menu item and set.

Procedures to set the Quality Level on the [📷 Rec. Mode] menu is explained as an example.

3 Use the four-way controller (▲▼) to choose an item.

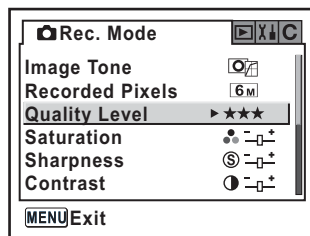

4 Press the four-way controller (▶).

Available Quality Level options appear.

Press the four-way controller (▶) to move to the sub-menu if there is one.

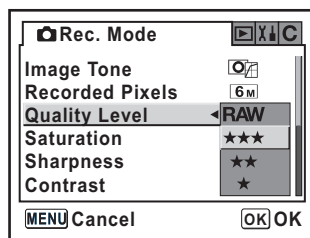

5 Use the four-way controller (▲▼) to select a setting.

6 Press the OK button.

The camera returns to the menu screen. Next, set other items.

Press the **MENU** button to return to Capture or Playback mode.



Even after you press the **MENU** button and close the menu screen, your settings will not be saved if the camera is turned off improperly (such as by removing the batteries while the camera is on).

[📷 Rec. Mode] Menu Setting Items

Perform settings related to capturing in the [📷 Rec. Mode] menu.

Item	Function	Page
Image Tone	Set the color tone of pictures.	p.108
Recorded Pixels	Set the recording size of images.	p.109
Quality Level	Set the image quality.	p.110
Saturation	Set the color saturation.	p.111
Sharpness	Make the image outlines sharp or soft.	p.111
Contrast	Set the image contrast.	p.111
Instant Review	Set the Instant Review time.	p.170
Auto Bracket	Set Auto Bracket shooting.	p.145
AE Metering	Choose the part of the screen to use for measuring brightness and determining exposure.	p.130
Swthc dst msr pt	Choose the part of the screen to set focus to.	p.123
Flash Exp. Comp.	Adjust the amount of flash discharged.	p.146

[▶ Playback] Menu Setting Items

Perform settings related to playback and editing images in the [▶ Playback] menu.

Item	Function	Page
Plybk dsply mthd	Set capturing information to show during playback.	p.160
Hot spot wrngng	Set to display Hot spot warning during Instant Review or Playback.	p.160
Digital Filter	Edit captured images to black and white or sepia tint, or add softening and slimming effects.	p.71
Slideshow	Play back recorded images one after another.	p.68

[X] Set-up] Menu Setting Items

Perform various settings related to the camera in the [X] Set-up] menu.

Item	Function	Page
Format	Format the SD Memory Card.	p.162
Beep	Switch the beep tone on/off.	p.163
Date Adjust	Set the date format and time.	p.163
World Time	Set to enable displaying of local time when traveling abroad.	p.164
Language/言語	Change the language in which menus and messages appear.	p.167
Guide display	Set to display indicators in LCD monitor.	p.167
Brightness Level	Change the brightness of the LCD monitor.	p.168
Video Out	Set the output format to the TV monitor.	p.168
Transfer Mode	Set the USB cable connection (PC or printer).	p.84
Auto Power Off	Sets the time to turn off automatically.	p.169
File #	Set the method used to add file numbers.	p.169
Sensor Cleaning	Lock the mirror in the up position for cleaning the CCD.	p.180
Reset	Reset all settings other than Date/Time, Language/言語, Video Out and World Time.	p.171

[C Custom] Menu Setting Items

Set custom functions to fully use the functions of a SLR camera with the Custom Function Menu. The default setting does not use Custom Function.

[C Custom] menu settings are activated when [Settings], the first item, is (on).

Item	Function	Page
Settings	Set to use the Custom Function Menu.	—
Noise Reduction	Set to use Noise Reduction at slower shutter release speeds.	—
Expsr Setting Steps	Set the adjustment steps for exposure.	p.142
Sensvtvy Corction	Set to automatically correct sensitivity to proper value.	p.115
ISO Snsvtvy Wrn Dspl	Set the maximum sensitivity level. ISO Sensitivity Warning Display appears when exceeded.	p.116
Link AF Point and AE	Set to adjust AE in multi-segment metering based on AF point.	p.131
Meter Operating Time	Set the exposure metering time.	p.132
AE-L with AF locked	Set to fix exposure value when focus is locked.	p.126
Recordable Image No.	Set to switch number of recordable images in the LCD panel and viewfinder to number of continuous shooting recordable images when shutter release button is pressed halfway.	—
OK btn when shooting	Set the action for the OK button when pressed during shooting.	p.120 p.124
Superimpose AF Area	Set to display superimposed AF area in the finder.	p.123
AF in remote control	Set to use Autofocus when shooting with remote control. Shutter releases after AF activates if shutter is released from remote control when [On]. Shutter cannot be released until in focus. AF does not activate at shutter release from remote control when [Off].	—

Item	Function	Page
FI with S lens used	Set to enable focus indicator when screw mount lens is in use. Lens is recognized even when lens is not attached to the camera when enabled.	—
Using aperture ring	Set to disable shutter release when lens aperture ring is set at other than A .	p.179
Release when Chrging	Set to release shutter while the built-in flash is charging.	p.147
Instant Review Dsply	Set to display histogram during Instant Review.	p.170
Mag to Strt Zm Plybk	Set the initial magnification of the zoom playback. Choose from [1.2 times], [2 times], [4 times], [8 times] and [12 times]. The default setting is [1.2 times].	—
Man. WB Measurement	Set to meter entire screen or Spot area when setting white balance to manual.	p.113
Color Space	Set the color space to use.	p.117
Reset Custom Fnction	Reset all the settings in the Custom Function menu to the defaults.	p.172

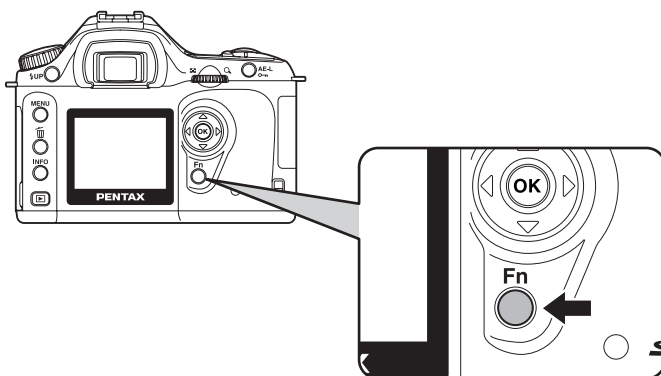

Capture Mode

Press the **Fn** button while taking a picture.
The Fn menu appears.

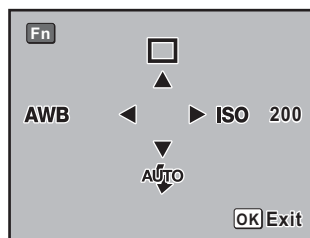

Press the four-way controller (▲▼◀▶) to set the operation.

Four-way controller	Item	Function	Page
▲	Drive Mode	Select Continuous shooting, Self-Timer, Remote control or Auto bracket.	p.53, p.55, p.59, p.145
▼	Flash Mode	Adjust the method of flash discharge.	p.49
◀	White Balance	Adjusts the color of the subject to a color that is of appropriate light source illumination.	p.112
▶	Sensitivity	Set the sensitivity.	p.115

Playback

Press the **Fn** button during playback. The Fn menu appears.

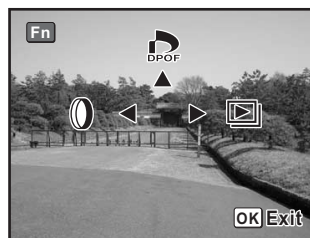

Press the four-way controller (▲◀▶) to set the operation.

Four-way controller	Item	Function	Page
▲	DPOF Settings	Set the DPOF settings.	p.79
◀	Digital Filter	Edit captured images to black and white or sepia tint, or add softening and slimming effects.	p.71
▶	Slideshow	Play back recorded images one after another.	p.68

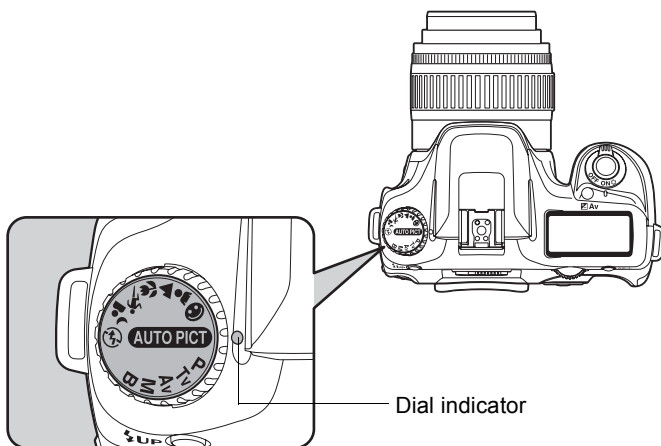

You can switch the Shooting mode by setting the icons on the mode dial to the dial indicator.

Item	Function	Page
(Auto Picture)	Selects automatically from Normal, Portrait, Landscape, Macro, and Moving Object Modes.	p.47
(Normal)	The basic picture-taking mode.	
(Portrait)	Optimal for capturing portraits.	
(Landscape)	Deepens the focus range, emphasizes contour and saturation of trees and the sky produces a bright image.	
(Macro)	Take vibrant pictures of flowers up close.	
(Moving Object)	Lets you take sharp pictures of a quickly moving subject, such as a sporting event.	
(Night Scene Portrait)	Lets you capture people against a night view or nightscape.	
(Flash OFF)	The flash is deactivated. Other settings are the same as Normal ().	

Item	Function	Page
P (Program)	Shutter speed and aperture are automatically set to the proper exposure when taking pictures.	p.133
Tv (Shutter Priority)	Set shutter speed and use to express the motion of moving subjects. Take pictures of fast moving subjects that look still or subjects that look lively.	p.134
Av (Aperture Priority)	Set aperture and use when you want to adjust the depth of view. Use to blur or focus on the background.	p.136
M (Manual)	Combine set shutter speed and aperture to create the picture you have in mind.	p.138
B (Bulb)	Use to capture images that require slow shutter speeds such as fireworks and night scenes.	p.140

5 Function Reference



Introduces functions to further enhance your **istDs* experience.

Setting the Recorded Pixels and Quality Level	108
Focusing	118
Setting the Exposure	127
Using the Built-in Flash	146
Settings During Playback	160
Camera Settings	162
Resetting to Default Settings	171

Setting the Recorded Pixels and Quality Level

Setting the Image Tone

Set the basic color tone of pictures. The default setting is [] (Bright).

	Bright	Images are finished brightly, contrasting and sharp.
	Natural	Images are finished naturally and suitable for retouching.

Set in [Image Tone] in the [ Rec. Mode] menu. (p.98)

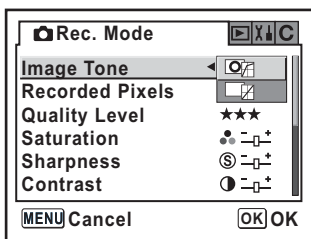

Setting is fixed to  (bright) when in Picture mode (p.47) regardless of settings.

Setting the Recorded Pixels

You can select the number of recorded pixels from **[6M]** (3008×2008/3008×2000), **[4M]** (2400×1600) and **[1.5M]** (1536×1024). The more pixels there are, the larger the picture and the bigger the file size. The file size will also differ according to quality level settings. The default setting is **[6M 3008×2000 (JPEG)]**.

[6M]	3008×2008 (RAW) 3008×2000 (JPEG)	Suited for printing on A3 paper.
[4M]	2400×1600	Suited for printing on A4 paper.
[1.5M]	1536×1024	Suited for printing on A5 paper.

Set in [Recorded Pixels] in the [ Rec. Mode] menu. (p.98)

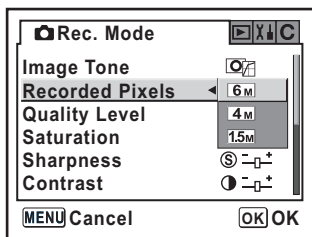

Recorded Pixels cannot be selected if the Quality Level is set to RAW. (Fixed at 3008×2008)

Setting the Quality Level

You can set the image quality level. The file size will also differ according to the Recorded Pixels settings. The default setting is [★★★ (Best)].

RAW	RAW	RAW data is CCD output data saved without processing. Effects such as White Balance, Contrast, Saturation and Sharpness are not applied to the image but such information is saved. Transfer to a PC, apply effects with the enclosed PENTAX PHOTO Laboratory 2.0 and create JPEG and TIFF images.
★★★	Best	Lowest compression rate, suited for printing large pictures such as A4 size. Image is saved in JPEG format.
★★	Better	Standard compression rate, suited for viewing as photographs or on your computer screen. Image is saved in JPEG format.
★	Good	Highest compression rate, suitable for attaching to e-mail or posting on websites. Image is saved in JPEG format.

Set in [Quality Level] in the [📷 Rec. Mode] menu. (p.98)

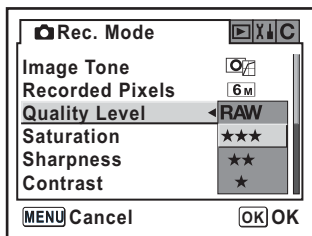

Setting the Saturation/Sharpness/Contrast

Select from five levels of Saturation, Sharpness and Contrast. The default setting is [0 (Standard)] for all.

Saturation	Set the color saturation.
Sharpness	Make the image outlines sharp or soft.
Contrast	Set the image contrast.

Set [Saturation], [Sharpness] and [Contrast] in the [📷 Rec. Mode] menu. (p.98)



These settings are canceled in Auto Picture Program and Picture mode.

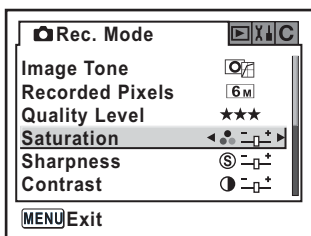

Towards + : Higher saturation

Towards - : Lower saturation

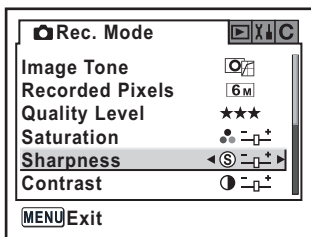

Towards + : Sharper

Towards - : Less sharp

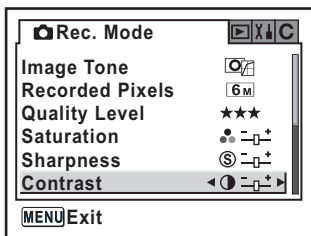







Towards + : Higher contrast

Towards - : Lower contrast

Setting the White Balance

The color of the subject changes with the light source. For example, the same white object will be a different shade of white in daylight than under a light bulb. In cameras using film, this is adjusted by changing the film or using filters. In digital cameras, the whiteness is adjusted using white balance. The default setting is [**AWB** (Auto)].

AWB	Auto	Set to automatically adjust the white balance. (About 4000 to 8000K)
	Daylight	Set when taking pictures in sunlight. (About 5200K)
	Shade	Set when taking pictures in the shade. (About 8000K)
	Cloudy	Set when taking pictures on cloudy days. (About 6000K)
	Fluorescent Light	Set this when taking pictures under fluorescent lighting. Select the type of fluorescent light, from W (white) (4200K), N (neutral white) (5000K), and D (daylight) (6500K).
	Tungsten Light	Set when taking pictures under light bulb or other tungsten light. (About 2850K)
	Flash	Set to take pictures using the built-in flash. (About 5400K)
	Manual	Set to take pictures by manually adjusting the white balance.

The color temperature (K) is an estimate. This does not indicate precise colors.

Set [White Balance] in the Fn menu. (p.102)

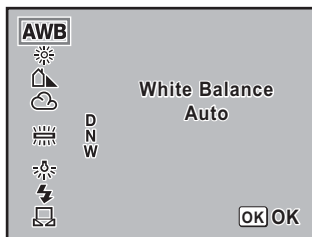

- Refer to p.113 for manual adjustment method.
- The above adjustment is not reflected in Picture mode.

Color Temperature

The color of light shifts towards blue as the color temperature rises, and towards red as the color temperature falls. Color temperature describes this change in light color in terms of absolute temperature (K: Kelvin). This camera is capable of setting the white balance to enable taking pictures with natural coloring under a variety of lighting conditions.

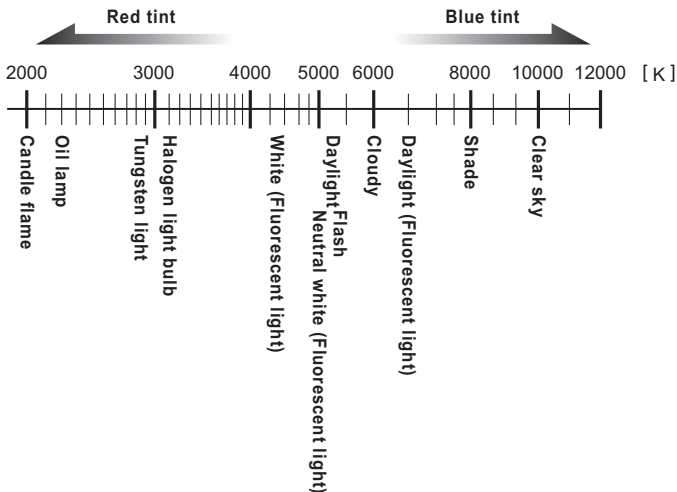

Adjusting the White Balance Manually

You can adjust the white balance depending on the light source when taking pictures. With Manual White Balance, the camera can store delicate shades that cannot be precisely adjusted with the white balance provided in the camera (p.112). This provides the optimum white balance for your surroundings.

1 Set the mode dial to **P**, **Tv**, **Av**, **M**, or **B**.

2 Press the **Fn** button.

The Fn menu appears.

3 Press the four-way controller (◀).

The White Balance screen appears.

- 4** Use the four-way controller (▼) to select [Manual] (Manual).

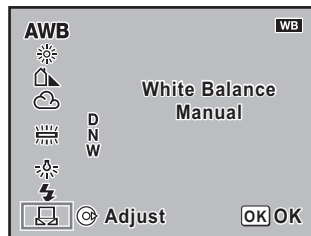

- 5** Press the four-way controller (▶).

The message screen appears.

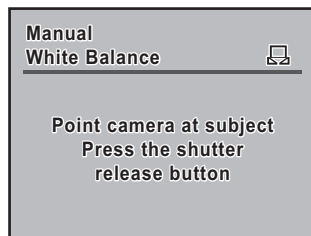

- 6** Fully display a white or gray sheet of paper in the viewfinder under the light to adjust white balance.

- 7** Press the shutter release button fully.

[OK] appears on the LCD monitor when setting is successful.

[NG] appears on the LCD monitor if setting is not successful.

- 8** Press the OK button.



- No image is recorded when the shutter release button is pressed to adjust the white balance.
- Press the **Fn** button again when setting is unsuccessful to set again.
- You can set the range to measure white balance when setting manually. White balance is measured using the entire screen using multi-segment metering (p.130) if [Entire screen] is selected for [Man. WB Measurement] in [C Custom] menu (p.101). White Balance is only adjusted in the spot metering area (p.131) if [Spot Metering Area] is selected.

Setting the Sensitivity

You can set the sensitivity to suit the brightness of the surroundings. The sensitivity can be set within a sensitivity range equivalent to ISO 200 to 3200. The default setting is [200].

Set [Sensitivity] in the Fn menu. (p.102)

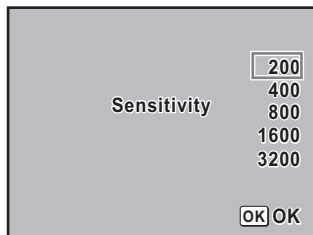

Captured images can show more noise if higher Sensitivity is set.

5

Correcting the Sensitivity Automatically

You can increase or lower the sensitivity if the subject is too light or dark, or if the aperture value in relation to the shutter speed or shutter speed in relation to the aperture value is not correct. Sensitivity is not corrected by default.

1	Off	Sensitivity is not corrected.
2	ISO 1600	Sensitivity is corrected within a range of 1600.
3	ISO 3200	Sensitivity is corrected within a range of 3200.

Set in [Sensvtvy Corction] in the [**C** Custom] menu. (p.100)

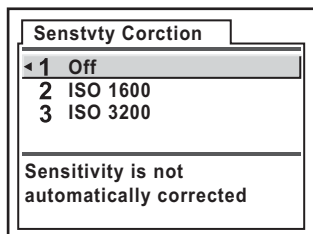



Sensitivity is not corrected in the following.

- Exposure mode is **M** (Manual) or **B** (Bulb) mode
- Flash is discharged
- Auto bracketing
- EV Compensation

ISO Sensitivity Warning Display

ISO Sensitivity Warning appears in the viewfinder when the set sensitivity is exceeded. Set a sensitivity that is not regularly used to avoid forgetting to reset when sensitivity is raised. ISO Sensitivity Warning is not displayed by default.

1	Off	ISO Sensitivity Warning is not displayed.
2	ISO 400	ISO Sensitivity Warning is displayed when ISO 400 is set or exceeded.
3	ISO 800	ISO Sensitivity Warning is displayed when ISO 800 is set or exceeded.
4	ISO 1600	ISO Sensitivity Warning is displayed when ISO 1600 is set or exceeded.
5	ISO 3200	ISO Sensitivity Warning is displayed when ISO 3200 is set.

5

Function Reference

Set in [ISO Snstvy Wrn Dspl] in the [**C** Custom] menu. (p.100)

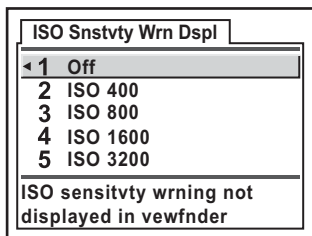

[**ISO** (ISO Sensitivity Warning)] appears in the viewfinder when the set sensitivity is exceeded.



ISO Sensitivity Warning is not displayed if sensitivity is automatically corrected (p.115).

Setting the Color Space

You can set the color space to use. The default setting is [1 (sRGB)].

1	sRGB	Set to sRGB color space.
2	AdobeRGB	Sets to AdobeRGB color space.

Set in [Color Space] in the [**C** Custom] menu. (p.101)

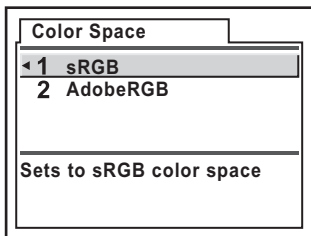

Color Space

Color ranges for various input/output devices, such as digital cameras, monitors, and printers, differ.

This color range is called the Color Space.

To recreate different color spaces in different devices, standard color spaces have been proposed. This camera supports sRGB and AdobeRGB.

sRGB is mainly used for devices such as a PC.

AdobeRGB covers a wider area than sRGB and is used for occupational uses such as industrial printing.

An image created in AdobeRGB may appear lighter than an image created in sRGB when output from a sRGB compatible device.

You can focus with the following methods.

AF	Autofocus	The camera is focused when the shutter release button is pressed halfway. Focus is locked on the area shown when shutter release button is pressed halfway.
MF	Manual focus	Manually adjust the focus.

Select the area in the viewfinder to focus (focus point) from [Auto], [Select] and [Center]. (p.123)

Using the Autofocus

5

Function Reference

- 1 Set the focus mode lever to **AF**.

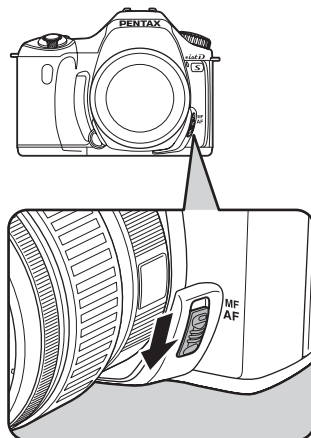

- 2 Look through the viewfinder and press the shutter release button halfway.



Focus indicator  appears in the viewfinder when focused.

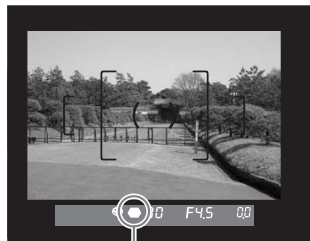

(If it is blinking, the subject is not in focus.)

 Hard-to-Autofocus Subjects (p.46)



Focus indicator



- The focus is locked (focus lock) while  is lit. To focus on another subject, take your finger off of the shutter release button first.
- Automatic continuous autofocus activates and focus is not locked when the shutter release button is pressed halfway during  (Moving Object) mode. Focus point nor focus is locked and focuses each time when the shutter release button is pressed halfway during continuous autofocus.
- The shutter cannot be released until the subject is in focus in **AF**. If the subject is too close to the camera, move back and take the picture. Adjust the focus manually if the subject is difficult to focus (p.46). (p.121)
- Press the shutter release button halfway. The built-in flash will discharge automatically several times, enabling the autofocus to focus on the subject easier if the subject is in a dark area and the built-in flash is up.

Use the OK Button to Focus on the Subject

You can set so that the focusing performed when the shutter release button is pressed halfway is canceled and is performed when the **OK** button is pressed.

Set [2 (Enable AF)] in [OK btn when shooting] in the [**C** Custom] menu. (p.100)

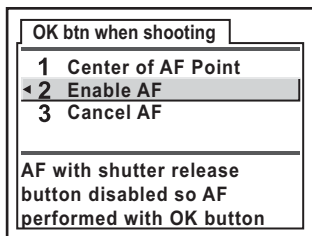

5

Function Reference



Select [3 (Cancel AF)]. **MF** appears in the viewfinder while the **OK** button is pressed. Autofocus does not activate when the shutter release button is pressed. This is useful when you wish to temporarily use manual focus while using autofocus.

You can focus using the focus ring and release the shutter while **OK** button is pressed when using a lens compatible with Quick Shift Focus. (Let go of the **OK** button to immediately return to AF mode.)



Only use this function with lenses that are compatible with Quick Shift Focus.

Adjusting the Focus Manually (Manual Focus)

When you adjust the focus manually, you can either check with the focus indicator in the viewfinder or use the viewfinder matte field to adjust focus.

Using the Focus Indicator

You can manually adjust the focus using the focus indicator .

- 1 **Set the focus mode lever to MF.**

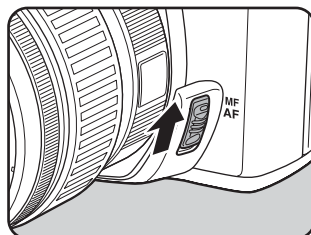

- 2 **Look through the viewfinder and press the shutter release button halfway and turn the focusing ring.**

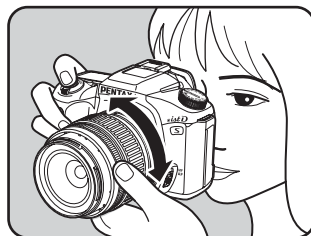

The focus indicator  appears and you will hear a beep when the subject comes into focus.

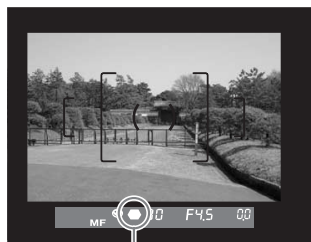

Focus indicator



- Use the matte field in the viewfinder when the subject is difficult to focus (p.46) and the focus indicator will not stay lit.
- The beep can be turned off. (p.163)

Using the Viewfinder Matte Field

You can manually adjust the focus using the viewfinder matte field.

- 1** Set the focus mode lever to **MF**.

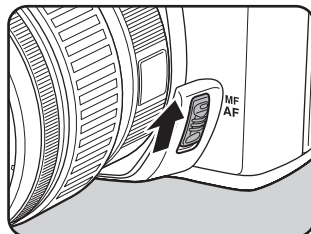

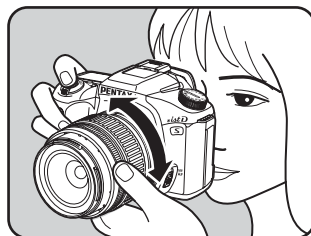

- 2** Look through the viewfinder and turn the focusing ring until the subject looks sharp on the screen.



Selecting the Focus Point (Focus Point)

Choose the part of the viewfinder to set focus to. The default setting is **[AUTO (Auto)]**.

The selected focus point lights red in the viewfinder.

	Auto	The camera selects the optimum focus point even if the subject is not centered.
	Select	Set the AF area to one of the eleven areas in the AF area.
	Center	Set the focus to the center of the viewfinder.

Set in [Swch dst msr pt] in the [ Rec. Mode] menu (p.98).

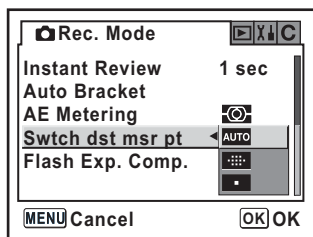

Focus point is not displayed in the viewfinder when [2 (Off)] is selected for [Superimpose AF Area] in the [**C** Custom] menu. (p.100)

Setting the Focus Position in the Viewfinder

- 1 Select [ (Select)] in [Swtch dst msr pt] in the [📷 Rec. Mode] menu.
- 2 Look through the viewfinder and check the position of the subject.

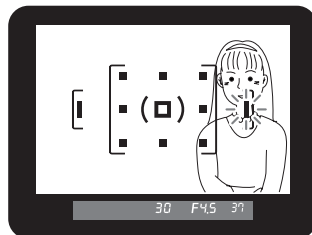

- 3 Use the four-way controller (▲ ▼ ◀ ▶) to select the desired focus point.

The focus point lights red in the viewfinder (Superimpose AF Area) and you can check where you set the focus point.



- The focus point is set to the center of the AF point by pressing the **OK** button when [OK btn when shooting] in the [C Custom] menu is set to the default setting (1 Center of AF Point) and the focus point other than center is selected for  (Select).
- The focus point is fixed to the center position regardless of this setting with lenses other than DA, D FA, FA J, FA or F lenses.

Fixing the Focus (Focus Lock)

If the subject is outside of the range of the focus point area, the camera cannot automatically focus on the subject. In this situation, you can aim the focus point on the subject, use focus lock and recompose the picture.

1 Frame the desired composition for your picture in the viewfinder.

You can use focus lock function when the subject you wish to focus on is not inside the focus point area.

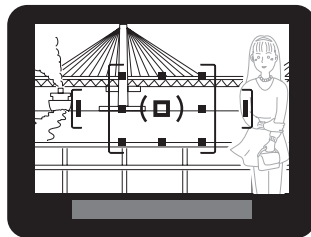

(Example)

The person is out of focus and the background is focused instead.

2 Center the subject to focus in the viewfinder and press the shutter release button halfway.

The focus indicator  appears and you will hear a beep when the subject comes into focus. (If it is blinking, the subject is not in focus.)

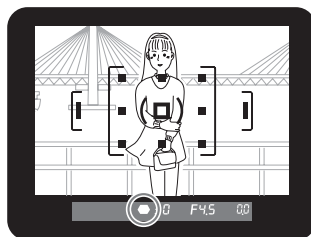



3 Lock the focus.

Keep the shutter release button pressed halfway. The focus will remain locked.

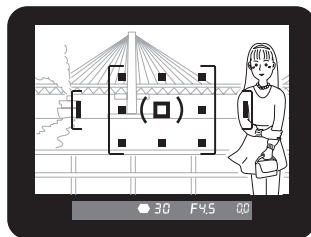
4 Re-compose the picture while keeping the shutter release button pressed halfway.



- The focus is locked while the focus indicator  is lit.
- Turning the zooming ring in focus lock mode may cause the subject to be out of focus.
- The beep can be turned off. (p.163)
- You cannot set focus lock when capture mode is  (Moving Object). Autofocus is active until shutter is released. (Continuous Autofocus)

5

Fixing Exposure when Focus is Locked

Set [AE-L with AF locked] in the [C Custom] menu (p.100) to fix the exposure value while focus is locked. Exposure is not fixed by default during focus lock.

1	Off	Exposure is not fixed when focus is locked
2	On	Exposure is fixed when focus is locked

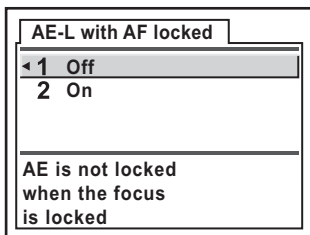

Effect of Aperture and Shutter Speed

Correct exposure of the subject is determined by the combination of shutter speed and aperture setting. There are many correct combinations of shutter speed and aperture for a particular subject. Different combinations produce different effects.

Effect of Shutter Speed

The shutter speed determines the length of time that light is allowed to strike the CCD. Adjust the amount of light striking the CCD.

- **Using slower shutter speed**

If the subject is moving, the image will be blurred because the shutter is open longer.

It is possible to enhance the effect of motion (rivers, waterfalls, waves, etc.) by intentionally using a slower shutter speed.

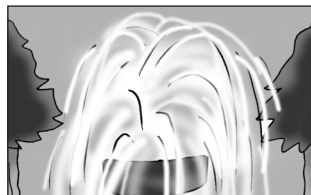

- **Using faster shutter speed**

Choosing a faster shutter speed will allow freezing the action of a moving subject.

A faster shutter speed also helps prevent camera shake.

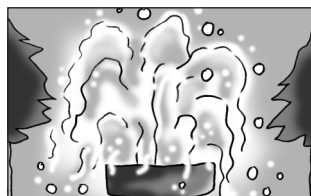

Effect of Aperture

Adjust the amount of light hitting the CCD by changing the aperture.

● Opening the aperture (reduce the aperture value)

Objects closer and farther than the focused subject will be more out of focus. For instance, if you take a picture of flower against a landscape with the aperture open, the landscape in front and behind the flower will be blurred, emphasizing only the flower.



● Closing the aperture (increase the aperture value)

The range in focus expands forward and backward. For instance, if you take a picture of flower against a landscape with the aperture narrowed, the landscape in front and behind the flower will be in focus.



5

Function Reference

Depth of Field

When you focus on a portion of the subject, there is a range in which object closer and farther will also be in focus. This focused range is called the depth of field.

- The depth of field for the **istDS* differs depending on the lens but compared to a 35 mm camera, the value is roughly one aperture setting lower (the focused range becomes narrower). Further, check the depth of field at one stop open side for lenses with a depth of field scale.
- The wider the wide-angle lens, and the farther away the subject, the wider the depth of field is. (Some zoom lenses do not have a scale for depth of field because of their structure.)

Depth of Field	Shallow	←————→	Deep
Area of focus	Narrow	←————→	Wide
Aperture	Open (Smaller value)	←————→	Close (Larger value)
Lens focus length	Longer (Telephoto)	←————→	Shorter (Wider)
Distance to the subject	Near	←————→	Far

How to Check Depth of Field

When you focus on a portion of the subject, there is a range in which object closer and farther will also be in focus. This focused range is called the depth of field. If you use Depth of Field confirmation, you can check the depth of field in the viewfinder before taking a picture.

1 Focus on the subject.

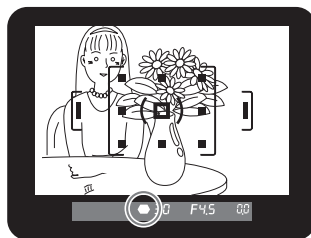

2 Turn the main switch to while looking through the viewfinder.

You can check the depth of field in the viewfinder while holding down the main switch.

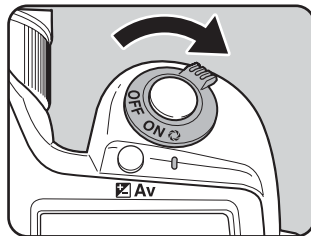

- No shooting information is displayed in the viewfinder, and the shutter cannot be released while the main switch is in the preview position (.
- You can check the depth of field in all exposure modes.

Selecting the Metering Method

Choose the part of the screen to use for measuring brightness and determining exposure. [Multi-segment metering], [Center-weighted metering] or [Spot metering] mode can be selected. The default setting is [Multi-segment].

	Multi-segment	Segment the screen in 16 parts, meter each portion and determine the appropriate exposure.
	Center-weighted	Measure the entire screen with an emphasis on the center and determine the exposure.
	Spot metering	Measure only the center of the screen and determine exposure.

Set in [AE Metering] in the [Rec. Mode] menu. (p.98)

5

Function Reference

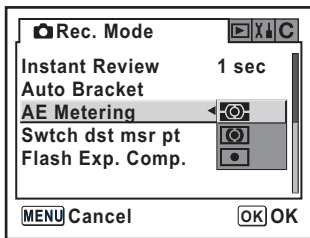

Using the Multi-Segment Metering

The scene in the viewfinder is metered in 16 different zones as shown in the illustration when using the multi-segment metering. This mode automatically determines what level of brightness is in which portion.

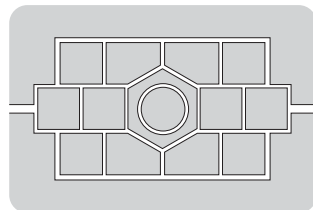

The center-weighted metering mode is automatically set even if you select the multi-segment metering mode when using a lens other than a DA, D FA, FA J, FA, F or A lens. (Can only be used if permission is set in [Using aperture ring] in the [C Custom] menu (p.101).)

Linking AF Point and AE During Multi-Segmented Metering

You can link the exposure and focus point during Multi-segment metering in [Link AF Point and AE] in the [C Custom] menu (p.100). The default setting is [1 (Off)].

1	Off	Exposure is set separately from focus point.
2	On	Exposure is set in accordance with focus point.

Using the Center-Weighted Metering

Metering is weighted at the center of the screen. Use this metering when you want to compensate the exposure by experience, instead of leaving it to the camera. The illustration shows that sensitivity increases as the pattern height increases (center). This mode does not automatically compensate for backlit scenes.

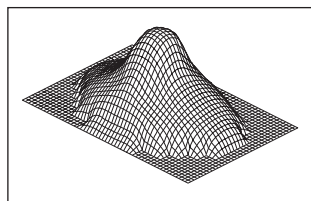

5

Using the Spot Metering

With spot metering, brightness is measured only within a limited area at the center of the screen as shown in the illustration. You can use this in combination with the AE lock (p.142) when the subject is extremely small and proper exposure is difficult to obtain.

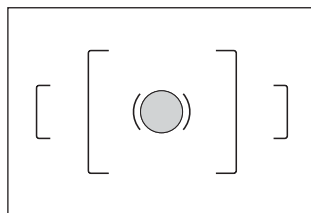

Setting the Meter Operating Time

Set the metering time in [Meter Operating Time] in the [C Custom] menu (p.100). The default setting is [1 (10 sec)].

1	10 sec	Set to 10 seconds.
2	3 sec	Set to 3 seconds.
3	30 sec	Set to 30 seconds.

Changing the Exposure Mode

This camera features five exposure modes along with the picture modes. Use the mode dial (p.104) to change the exposure mode.

Exposure Mode	Description	Exposure Compensation	Change Shutter Speed	Change Aperture
P (Program)	Shutter speed and aperture are automatically set for taking pictures at the proper exposure.	Yes	No	No
Tv (Shutter Priority)	Set shutter speed and use to express moving subjects. Take pictures of fast moving subjects that look still or subjects that look lively.	Yes	Yes	No
Av (Aperture Priority)	Set aperture and use when you want to adjust the depth of view. Use to blur the background.	Yes	No	Yes
M (Manual)	Combine set shutter speed and aperture to create the picture you have in mind.	No	Yes	Yes
B (Bulb)	Use to capture images that require slow shutter speeds such as fireworks and night scenes.	No	No	Yes

Using the P (Program) Mode

Shutter speed and aperture value are automatically set for taking pictures at the proper exposure.

Perform the following to adjust the exposure.

1 Set the mode dial to P.

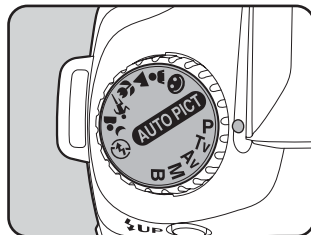

2 Turn the e-dial while pressing the \square Av button and adjust the exposure.

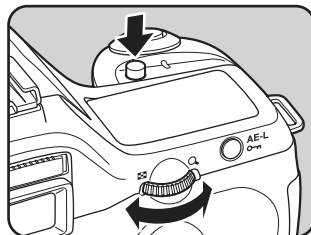

The EV Compensation is displayed on the viewfinder and the LCD panel.



EV Compensation

The shutter speed and aperture value are also displayed while adjusting the exposure.



- Set EV Compensation in increments of 1/2EV or 1/3EV. Set exposure setting steps in [Expsr Setting Steps] in the [C Custom] menu. (p.142)
- You can automatically correct the sensitivity if appropriate exposure cannot be set with the set criteria. Set in [Sensvty Corction] in the [C Custom] menu. (p.115)
- Set the aperture to the **A** position while holding down the auto-lock button when using a lens with an aperture ring.

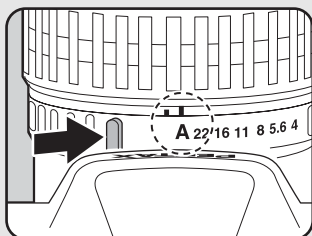

Using the Tv (Shutter Priority) Mode

Set shutter speed and use to express moving subjects. Set the shutter speed faster and capture fast moving subjects as if they are still or slow down the shutter and capture lively images. Aperture value is automatically set to appropriate exposure depending on the shutter speed.

☞ Effect of Aperture and Shutter Speed (p.127)

1 Set the mode dial to Tv.

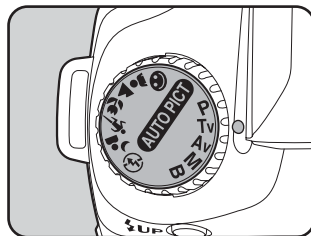

2 Turn the e-dial and adjust the shutter speed.

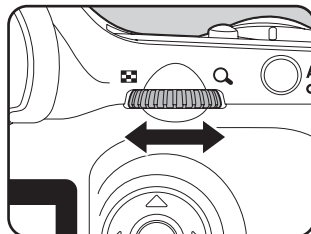

The shutter speed and aperture value are displayed on the viewfinder and the LCD panel.





- Turn the e-dial while pressing the **Av** button and change the EV Compensation value. (p.141)
- Set the shutter speed in increments of 1/2EV or 1/3EV. Set in [Expsr Setting Steps] in the [**C** Custom] menu. (p.142)
- You can automatically correct the sensitivity if appropriate exposure cannot be set with the set criteria. Set in [Senstvty Corction] in the [**C** Custom] menu. (p.115)
- Set the aperture to the **A** position while holding down the auto-lock button when using a lens with an aperture ring.

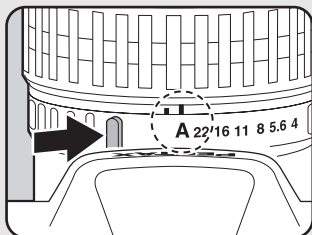

Exposure Warning

If the subject is too bright or too dark, the aperture value will blink in the viewfinder and on the LCD panel. If the subject is too bright, choose a faster shutter speed. If it is too dark, choose a slower shutter speed. When the shutter speed indication stops blinking, you can take the picture with proper exposure.

If both the shutter speed and aperture value are blinking, this indicates being out of metering range and the proper exposure cannot be obtained even if the shutter speed is adjusted.

Use an ND (Neutral Density) filter if the subject is too bright.

Use a flash if it is too dark.





- Turn the e-dial while pressing the **Av** button and change the EV Compensation value. (p.141)
- Set the aperture value in increments of 1/2EV or 1/3EV. Set in [Expsr Setting Steps] in the [**C** Custom] menu. (p.142)
- You can automatically correct the sensitivity if appropriate exposure cannot be set with the set criteria. Set in [Sensvty Corction] in the [**C** Custom] menu. (p.115)
- Set the aperture to the **A** position while holding down the auto-lock button when using a lens with an aperture ring.

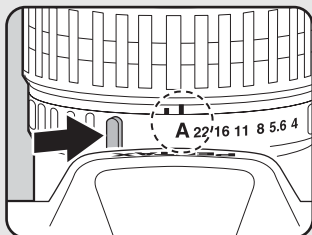

Exposure Warning

If the subject is too bright or too dark, the shutter speed will blink in the viewfinder and on the LCD panel. If the subject is too bright, set the aperture

smaller (larger number), and when too dark, open the aperture further (smaller number). Once blinking stops, you can take the picture. If both the shutter speed and aperture value are blinking, this indicates being out of metering range and the proper exposure cannot be obtained even if the aperture is adjusted.

Use an ND (Neutral Density) filter if the subject is too bright. Use a flash if it is too dark.



Using M (Manual) Mode

You can set the shutter speed and aperture value. This mode is suitable to take pictures of your choice by combining them. This mode is a convenient for taking pictures using the same shutter speed and aperture setting combination or taking intentionally under-exposed (darker) or over-exposed (brighter) photographs.

☞ Effect of Aperture and Shutter Speed (p.127)

1 Set the mode dial to M.

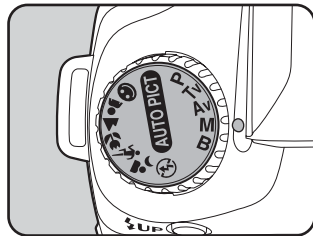

2 Turn the e-dial and adjust the shutter speed.

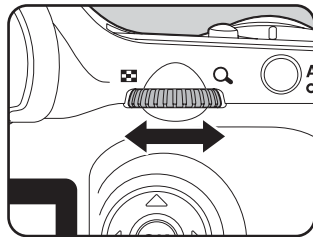

3 Turn the e-dial while pressing the \square Av button and adjust the aperture.

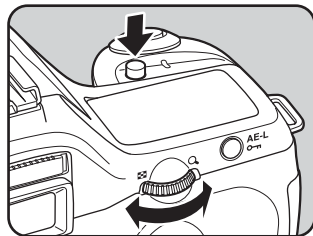

The shutter speed and aperture value are displayed on the viewfinder and the LCD panel. Of the shutter speed and aperture, the value being adjusted is underlined in the viewfinder. While adjusting the shutter speed or aperture value, the difference with the appropriate exposure (EV value) appears at the bottom right of the viewfinder. The appropriate exposure is when [0.0] is displayed.



Difference from the appropriate exposure



- Blinks when the difference with appropriate exposure is over ± 3.0 .
- Set the shutter speed and aperture values in increments of $1/2EV$ or $1/3EV$. Set in [Expsr Setting Steps] in the [C Custom] menu. (p.142)
- Set the aperture to the **A** position while holding down the auto-lock button when using a lens with an aperture ring.

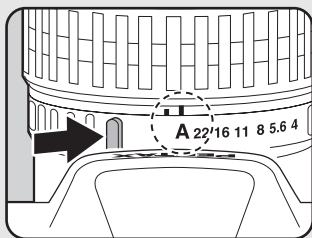

Exposure Warning

You are out of the measuring area if the shutter speed and aperture blink.

Use an ND (Neutral Density) filter if the subject is too bright.

Use a flash if it is too dark.



About the AE-L Button

The aperture and shutter speed are automatically adjusted to the appropriate exposure at that moment if the **AE-L** button is pressed in **M** (Manual) mode.

Shutter speed is adjusted to appropriate exposure according to lens aperture when lens aperture is not set to **A** position.

☞ Notes on [Using Aperture Ring] (p.179)

Using the **B** (Bulb) Mode

This mode is useful for the long exposures required for shooting night scenes and fireworks.

1 Set the mode dial to **B**.

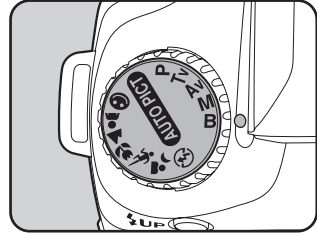



- Turn the e-dial to adjust the aperture value.
- Set the aperture value so that EV Compensation is performed in increments of 1/2EV or 1/3EV. Set in [Expsr Setting Steps] in the [**C** Custom] menu. (p.142)
- Use a sturdy tripod and the cable switch CS-205 (optional) to prevent camera shake when using **B** (bulb) mode. Connect the cable switch to the cable switch terminal (p.15).
- Bulb shooting is available when using the remote control shooting mode (p.59). The shutter remains open as long as the optional remote control's shutter release button is held down.
- Noise reduction is a process to reduce noise (image roughness or unevenness) caused by low shutter speed. Set in [Noise Reduction] in the [**C** Custom] menu. (p.100)

Setting the Exposure

This allows you to deliberately over-expose (brighten) or under-expose (darken) your picture. You can adjust the EV Compensation from -2 to $+2$ (EV) in increments of $1/2$ EV or $1/3$ EV.



Set in [Expsr Setting Steps] in the [**C** Custom] menu. (p.142)

- 1 **Set the compensation with the e-dial while the  Av button is pressed.**

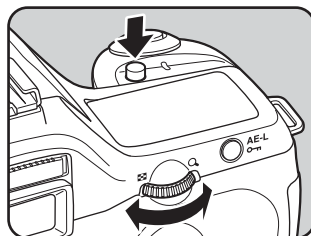
 Av button



- 2 **Confirm the compensation value in the viewfinder**

-  is displayed during compensation.
-  blinks when the flash is popped up if the flash compensation is set.



Compensation value



Exposure compensation is not available when the exposure mode is set to **M** (Manual) or **B** (Bulb) mode.



The exposure compensation cannot be canceled by turning the camera off or by setting any other exposure mode.

Changing the Exposure Setting Steps

Set Exposure Setting Steps in [Expsr Setting Steps] in [**C** Custom] to increments of 1/2EV or 1/3EV.

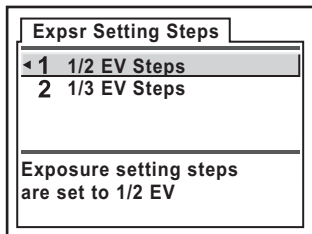

Recording the Exposure Before Shooting (AE Lock)

AE Lock is a function that memorizes the exposure prior to taking the picture. Use this when the subject is too small or backlit and a proper exposure setting cannot be obtained.

5

Function Reference

1 Press the **AE-L** button.

The camera memorizes the exposure (brightness) at that instant.

Press it again to unlock.

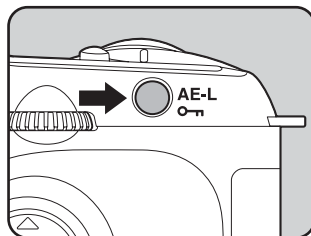

- * is displayed in the viewfinder while the AE lock is engaged. (p.20)
- The exposure remains in memory for twice as much time as the metering timer after releasing the **AE-L** button. The exposure remains locked as long as the **AE-L** button is kept pressed or the shutter release button is kept pressed halfway.
- You will hear a beep when the **AE-L** button is pressed. The beep can be turned off. (p.163)
- AE lock is not available when the exposure mode is set to **B** (Bulb) mode.
- The combination of shutter speed and aperture value changes depending on the zooming position even while the AE lock is engaged when using a zoom lens for which maximum aperture varies depending on the focus length. However, the exposure value does not change and the picture is taken at the brightness level set by the AE lock.
- If exposure mode is **M** (Manual), aperture and shutter speed are adjusted to set the appropriate exposure when the **AE-L** button is pressed.
- Exposure can be fixed when focus is locked. Set in [AE-L with AF locked] in the [**C** Custom] menu. (p.126)

Changing the Exposure and Shooting (Auto Bracket)

You can take continuous pictures with different exposure when the shutter release button is pressed. The first frame is exposed with no compensation, the second frame is under-exposed (negative compensation) and the third is over-exposed (positive compensation).



Normal exposure



Under-exposure



Over-exposure

1 Press the Fn button in capture mode.

The Fn menu appears.

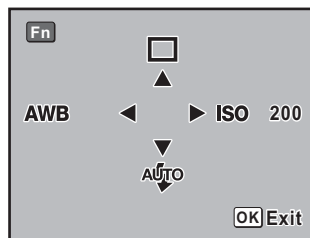

2 Press the four-way controller (▲).

The Drive Mode options screen appears.

3 Use the four-way controller (▶) to select [Auto Bracket] (Auto Bracket).

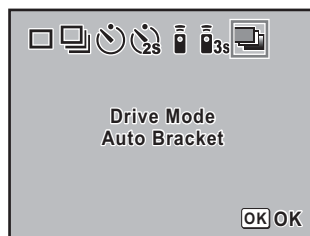

4 Press the OK button twice.

Shooting is ready and  is displayed on the LCD panel.

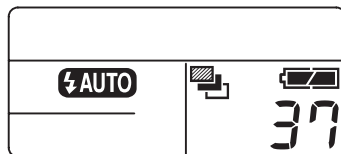

5 Press the shutter release button halfway.

Focus indicator  appears in the viewfinder when focused.

6 Press the shutter release button fully.

Three continuous pictures will be taken, the first with no compensation, the second with negative compensation, and the third with positive compensation.

5



- When the focus mode lever is set to **AF**, the focus is locked in the first frame position and used for subsequent continuous frames.
- The auto bracketing exposure setting will remain effective for twice as much time as the metering timer (default setting is 20 seconds) (p.131) when you release your finger from the shutter release button during auto bracketing, and you can take the next picture at the next compensation value. In this case, auto focusing works for each frame. After about twice as much time as the metering timer (default setting is 20 seconds), the camera returns to settings for taking the first picture.
- You can combine Auto Bracket with the built-in flash or external flash (TTL and P-TTL auto only) to change only the flash output continuously. However, when using an external flash, holding the shutter release button down to take three continuous frames may cause the second and third frame to be taken before the flash is fully recharged. Always take one frame at a time after confirming that charging is complete.
- Auto Bracket is not available when the exposure mode is set to **B** (Bulb) mode.

Setting Auto Bracket

Change the shooting order and steps of Auto Bracket.

Bracketng amount (Step interval)	1/2EV	$\pm 0.5, \pm 1.0, \pm 1.5, \pm 2.0$
	1/3EV	$\pm 0.3, \pm 0.7, \pm 1.0, \pm 1.3, \pm 1.7, \pm 2.0$
Shooting images		0 → - → +, - → 0 → +, + → 0 → -

* Set interval of steps in [Expsr Setting Steps] in the [C Custom] menu. (p.142)

Set in [Auto Bracket] in the [📷 Rec. Mode] menu. (p.98)

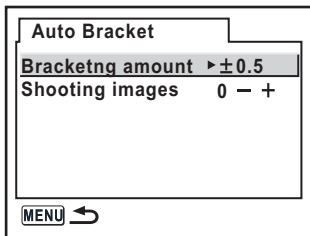

Taking Only Over-exposed or Under-exposed Pictures

You can use the auto bracketing mode for only under-exposure or over-exposure shots by combining the operation with exposure compensation (p.141). The auto bracketing is performed in both cases on the basis of the specified exposure compensation value.

Compensating Flash Output

You can change the flash output in a range of -2.0 to $+1.0$. The Flash Compensation values are as follows for 1/3EV and 1/2EV.

Step interval	Flash Compensation
1/2EV	$-2.0, -1.5, -1.0, -0.5, 0.0, +0.5, +1.0$
1/3EV	$-2.0, -1.7, -1.3, -1.0, -0.7, -0.3, 0.0, +0.3, +0.7, +1.0$

* Set interval of steps in [Expsr Setting Steps] in the [C Custom] menu. (p.142)

Set in [Flash Exp. Comp.] in the [Rec. Mode] menu. (p.98)

5

Function Reference

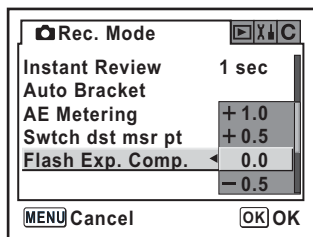

-  blinks in the viewfinder when the flash pops up during Flash Compensation. (p.20)
- If the maximum flash output is exceeded when corrected to the plus (+) side, no compensation will be effective.
- Compensating to the minus (-) side may not effect the image if the subject is too close, aperture is low or sensitivity is high.

Allowing Shooting while Charging Flash

You can set to enable shooting while flash is being charged.
Set [2 (On)] for [Release when Chrging] in the [C Custom] menu (p.101).
Pictures cannot be taken while the flash is charging by default.

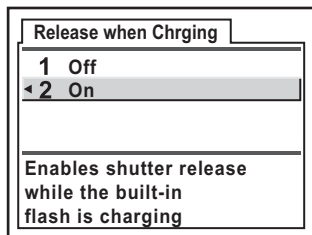

Flash Characteristics in Each Exposure Mode

5

Using the Flash in Tv (Shutter Priority) Mode

- When taking a moving subject, you can use the flash to change the blur effect.
- Any desired shutter speed 1/180 sec. or slower can be set for taking a flash photograph.
- The aperture value automatically changes according to the ambient brightness.
- The shutter speed is fixed at 1/180 sec. when lens other than DA, D FA, FA J, FA or F is used. (The built-in flash always discharges fully.)

Using the Flash in Av (Aperture Priority) Mode

- You can set the desired aperture to take a flash photograph when you want to change the depth of field or shoot a subject farther away.
- The shutter speed automatically changes with the ambient brightness.
- The shutter speed shifts automatically anywhere from 1/180 sec. to a slow shutter speed (p.42) that reduces camera shake. The slowest shutter speed depends on the focal length of the lens in use.
- The shutter speed is fixed at 1/180 sec. when lens other than DA, D FA, FA J, FA or F is used. (The built-in flash always discharges fully.)

Using Slow-Speed-Sync

You can use slow-speed-sync when shooting portraits with the sunset in the background. Both the portrait and the background are captured beautifully.



- Slow-speed-sync slows the shutter speed. Use a tripod to avoid camera shake. The picture will also blur if the subject moves.
- Slow-speed-sync shooting can also be performed with an external flash.

● Using Tv (Shutter Priority) Mode

- 1 Set the mode dial to **Tv**.
Tv (Shutter Priority) mode is set.
- 2 Use the e-dial to set the desired shutter speed.
The background is not properly corrected if aperture value is flashing when shutter speed is set. Set the shutter speed so that aperture does not flash.
- 3 Press the **⚡UP** button.
The flash pops up.
- 4 Take the picture.

● Using M (Manual) Mode

- 1 Set the mode dial to **M**.
M (Manual) mode
- 2 Set the shutter speed (under 1/180 sec.) and aperture value to obtain correct exposure.
- 3 Press the **⚡UP** button.
The flash pops up.
In **M** (Manual) mode, pop up the flash at any time.
- 4 Take the picture.

Distance and Aperture when Using the Built-in Flash

A set criteria is necessary between the guide number, aperture and distance when shooting with the flash.

Calculate and adjust the shooting conditions if flash is not sufficient.

Flash guide number for built-in flash

Sensitivity	Built-in flash guide number
ISO200	15.6
ISO400	22
ISO800	31
ISO1600	44
ISO3200	62

Calculating Shooting Distance from Aperture Value

The following equation calculates the distance of the flash for aperture values.

Maximum flash distance $L1 = \text{Guide Number} \div \text{Selected aperture}$

Minimum flash distance $L2 = \text{Maximum flash distance} \div 5^*$

* The value 5 used in the formula above is a fixed value which applies only when using the built-in flash alone.

Example

When sensitivity is [ISO200] and aperture value is F4

$L1 = 15.6 \div 4 = \text{approx. } 3.9 \text{ (m)}$

$L2 = 3.9 \div 5 = \text{approx. } 0.8 \text{ (m)}$

Therefore, the flash can be used in a range of about 0.8 m to 3.9 m.

The flash cannot be used when the distance is less than 0.7 m. When the flash is used at closer than 0.7 m, it causes vignetting in the picture corners, light is distributed unevenly and the picture may be over-exposed.

Calculating Aperture Value from Shooting Distance

The following equation calculates the aperture value for shooting distances.

Aperture Value Used $F = \text{Guide number} \div \text{shooting distance}$

When sensitivity is [ISO200] and shooting distance is 5.2 m, aperture value is:

$$F = 15.6 \div 5.2 = 3$$

If the resulting number (3, in the above example) is not available as a lens aperture, the smaller number that is closest (2.8, in the above example) is generally used.

DA, D FA , FA J, FA and F Lens Compatibility with the Built-in Flash

When using DA, D FA, FA J, FA and F lenses with the **istDS* without the hood, built-in flash compatibility is shown below.

Yes : Available

: Available depending on other factors

No : Unavailable due to vignetting

Following are evaluated without a hood.

Lens Name	Compatibility
F Fish-eye zoom 17 to 28 mm F3.5 to 4.5	# Vignetting may occur if focus distance is less than 20 mm.
DA Zoom 16 to 45 mm F4ED AL	# When the focus distance is less than 28 mm or when the focus distance is 28 mm and the shooting distance is less than 1m, vignetting may occur.
FA J zoom 18 to 35 mm F4 to 5.6 AL	# Vignetting may occur if focus distance is 18 mm and the shooting distance is less than 1m.
DA Zoom 18 to 55 mm F3.5 to 5.6 AL	Yes
FA Zoom 20 to 35 mm F4AL	Yes
FA Zoom 24 to 90 mm F3.5 to 4.5AL (IF)	Yes
FA Zoom 28 to 70 mm F4AL	Yes
FA* Zoom 28 to 70 mm F2.8AL	# Vignetting may occur if focus distance is between 28 and 35 mm and the shooting distance is less than 1m.
FA J Zoom 28 to 80 mm F3.5 to 5.6	Yes
FA Zoom 28 to 80 mm F3.5 to 5.6	Yes
FA Zoom 28 to 90 mm F3.5 to 5.6	Yes
FA Zoom 28 to 105 mm F4 to 5.6	Yes
FA Zoom 28 to 105 mm F4 to 5.6 (IF)	Yes
FA Zoom 28 to 105 mm F3.2 to 4.5AL (IF)	Yes
FA Zoom 28 to 200 mm F3.8 to 5.6AL (IF)	Yes
FA Zoom 35 to 80 mm F4 to 5.6	Yes
FA Zoom 70 to 200 mm F4 to 5.6	Yes

Lens Name	Compatibility
FA J Zoom 75 to 300 mm F4.5 to 5.8AL	Yes
FA* Zoom 80 to 200 mm F2.8ED (IF)	Yes
FA Zoom 80 to 320 mm F4.5 to 5.6	Yes
FA Zoom 80 to 200 mm F4.7 to 5.6	Yes
FA Zoom 100 to 300 mm F4.7 to 5.8	Yes
FA* Zoom 250 to 600 mm F5.6ED (IF)	No
DA14 mm F2.8ED (IF)	No
FA20 mm F2.8	Yes
FA* 24 mm F2AL (IF)	Yes
FA28 mm F2.8AL	Yes
FA31 mm F1.8AL Limited	Yes
FA35 mm F2AL	Yes
FA43 mm F1.9 Limited	Yes
FA50 mm F1.4	Yes
FA50 mm F1.7	Yes
FA77 mm F1.8 Limited	Yes
FA*85 mm F1.4 (IF)	Yes
FA135 mm F2.8 (IF)	Yes
FA*200 mm F2.8ED (IF)	Yes
FA*300 mm F2.8ED (IF)	No
FA*300 mm F4.5ED (IF)	Yes
FA*400 mm F5.6ED (IF)	Yes
FA*600 mm F4ED (IF)	No
D FA Macro 50 mm F2.8	Yes
D FA Macro 100 mm F2.8	Yes
FA Macro 50 mm F2.8	Yes
FA Macro 100 mm F2.8	Yes
FA Macro 100 mm F3.5	Yes
FA* Macro 200 mm F4ED (IF)	Yes
FA Soft 28 mm F2.8	# Built-in flash always discharges fully.
FA Soft 85 mm F2.8	# Built-in flash always discharges fully.

Using an External Flash (Optional)

Using the optional external flash AF360FGZ enables a variety of flash modes, such as P-TTL auto flash mode, TTL auto flash mode, high-speed flash sync mode, and wireless mode. Available functions differ by the external flash being used. See the chart below for details.

(Yes: Available #: Restricted No: Not available)

Camera Function \ Flash	Built-in Flash	AF360FGZ	AF500FTZ AF330FTZ	AF400FTZ AF240FT AF140C
Red-eye reduction flash	Yes	Yes	Yes	No
Automatic flash discharge	Yes	Yes	Yes	Yes
After the flash is charged, the camera automatically switches to the flash sync speed.	Yes	Yes	Yes	Yes
Aperture is automatically set in P (Program) mode and Tv (Shutter Priority) mode.	Yes	Yes	Yes	Yes
Auto check in the viewfinder	No	No	Yes	Yes
P-TTL auto flash (appropriate sensitivity: 200 to 3200)	Yes* ¹	Yes* ¹	No	No
TTL auto flash (appropriate sensitivity: 200 to 400)	No	#* ² , * ⁶	#* ⁶	#* ⁶
Slow-speed sync	Yes	Yes	Yes	Yes
AF illuminator	Yes	Yes	Yes	Yes
Rear curtain sync flash* ³	#* ⁴	Yes	Yes	Yes
Contrast-control-sync flash* ³ mode	No	Yes	Yes	No
Slave flash	No	Yes	Yes* ⁵	No
Multiple flash	No	No	Yes* ⁵	No
High-speed flash sync	No	Yes	No	No
Wireless flash	No	Yes	No	No

*¹ When using DA, D FA, FA J, FA, F or A lens.

*² When a lens used in position other than aperture A.

*³ Shutter speed of 1/90 sec. or slower.

*⁴ Can be combined with AF360FGZ for rear curtain sync flash.

*⁵ Not available with AF330FTZ.

*⁶ Image may be underexposed near minimum aperture and overexposed near open aperture in lenses with bright F value.

About the LCD Panel Display for AF360FGZ

The AF360FGZ will automatically convert the field angle differential between 35 mm format and the **istDS* depending from the focus length of the lens you are using. (When using DA, D FA, FA J, FA or F lenses) The conversion indicator appears and the format size indicator disappears when the exposure metering timer of the **istDS* is on. (It returns to 35 mm format display when the exposure metering timer is turned off.)

Lens focus length	85mm	77mm	50mm	35mm	28mm	24mm	20mm	18mm
AF360FGZ LCD panel Exposure metering timer Off	85mm		70mm	50mm	35mm		28mm	24mm*
Exposure metering timer On	58mm		48mm	34mm	24mm		19mm	16mm*

* Using wide adaptor

5

Function Reference

Using P-TTL Auto Mode

Use this flash mode with the AF360FGZ flash unit. When flash mode is set to "P-TTL auto", the flash pre-fires right before taking pictures using 16-segment metering and allows more precise control. P-TTL auto is available in wireless flash mode.

- 1 Remove the cover of the hot shoe and attach the AF360FGZ.
- 2 Turn on the AF360FGZ.
- 3 Set the AF360FGZ flash mode to P-TTL auto.
- 4 Confirm that the flash is fully charged and then take the picture.



- P-TTL auto is only available with the AF360FGZ flash unit. The mode will be TTL auto when using another flash.
- The will light in the viewfinder when the flash is ready (fully charged).
- For details such as operation method and effective distance, please read the external flash manual.
- The flash does not discharge when the subject is bright enough when Flash Mode is or . Therefore, it may not be suitable for daylight-sync shooting.
- Never press the flash pop up button when any external flash unit is attached to the camera. The built-in flash will hit the external flash. If you want to use both at once, see p.157 for the connection method.

Using High-Speed Flash Sync Mode

With the AF360FGZ, you can discharge the flash to take a picture at a shutter speed faster than 1/180 second. High-speed flash sync can be used with the flash attached to the camera, or wireless.

Attaching and Using the AF360FGZ on the Camera

- 1 Remove the hot shoe cover and attach the AF360FGZ.
- 2 Turn the mode dial and set the exposure mode to **M**.
- 3 Turn on the AF360FGZ.
- 4 Set the AF360FGZ sync mode to HS  (high-speed flash sync.).
- 5 Confirm that the AF360FGZ is fully charged and then take the picture.



- The  will light in the viewfinder when the flash is ready (fully charged).
- High-speed flash sync is only available when the shutter speed is faster than 1/180 sec.
- High-speed flash sync is not available when the exposure mode is set to **B** (Bulb).

Using in Wireless Mode

Shoot using the flash without connecting the camera and flash with a cord by using two AF360FGZ units. The High-speed sync mode is also available in wireless mode.



Be sure to set the two AF360FGZ units to the same channel. See the AF360FGZ operating manual for details.

● Using in Wireless Mode

- 1 Place the AF360FGZ at the desired location.
- 2 Set the AF360FGZ power switch to [WIRELESS].
- 3 Set the AF360FGZ wireless mode to S (Slave).
- 4 Turn the camera mode dial and set the exposure mode to **P**, **Tv**, **Av** or **M** mode.
- 5 Set the AF360FGZ power switch on the camera to [WIRELESS].
- 6 Set the AF360FGZ wireless mode on the camera to **M** (Master) or **C** (Control).



- Wireless mode is not available for the built-in flash.
- Set the AF360FGZ wireless slave mode to SLAVE1.

Wireless Flash Control (P-TTL Flash Mode)

The following information is exchanged between the two AF360FGZ flash units before the flash is discharged when the AF360FGZ is used for wireless flash.

Press the shutter release button fully.

- 1 The camera's flash discharges a pre-flash. (The camera's flash mode is transmitted.)
- 2 The external flash unit discharges a pre-flash. (The subject's lighting condition is checked.)
- 3 The camera's flash unit discharges a pre-flash. (The required flash output is transmitted to the external flash.)
 - * The camera's flash will discharge another pre-flash to transmit the flash duration in HS \downarrow (High-speed sync).
- 4 The external flash discharges the main flash.



Set the AF360FGZ wireless slave mode to SLAVE1.

Red-Eye Reduction

As with the built-in flash, red-eye reduction is available with an external flash. This may not be available on some flashes or may have restrictions for usage conditions. See the chart on p.153.



- The red-eye reduction feature works even when only an external flash is used. (p.52)
- If red-eye reduction is used when the AF360FGZ or AF500FTZ is set as the slave unit or with the wireless function, the preflash for red-eye reduction will trigger the external flash. Do not use red-eye reduction when using a slave unit.

Rear Curtain Sync Flash

When using the built-in flash with AF360FGZ that is set to the rear curtain flash function, the internal flash will also use this mode. Confirm that both flash units are fully charged before shooting.

Using the Built-in Flash with the External Flash

As shown in the figure below, attach the hot shoe adapter F_G (optional) to the camera hot shoe and an off-camera shoe adapter F (optional) to the bottom of the external flash, and connect these with the extension cord F5P (optional). The off camera shoe adapter F comes with a tripod screw for securing to your tripod.

Only the P-TTL auto flash can be used in combination with the built-in flash.

When combining with the built-in flash

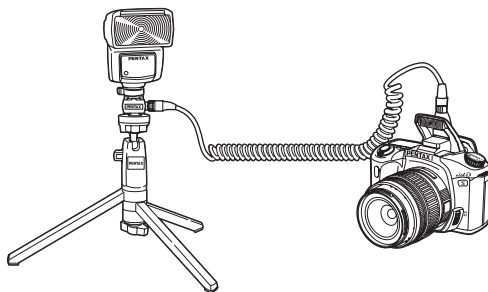

Discharging Multiple Flashes

To use two or more external flashes simultaneously, either use the same type of flashes as shown in the flash function chart on p.153 or use the combination of AF360FGZ/AF500FTZ/AF330FTZ and AF400FTZ/AF240FT. The built-in flash can be combined with any type. Connect them as shown in the figure below: Attach an off-camera shoe adapter F (optional) to the external flash and the hot shoe adapter F (optional) and connect the extension cord F5P (optional) to the off-camera shoe adapter F on the other external flash.



- Do not combine with accessories that have a different number of contacts such as a Hot Shoe Grip. A malfunction may occur.
- Combining with flashes from other manufacturers may cause equipment breakdown. We recommend using the PENTAX dedicated automatic flashes.

5

Function Reference

When combining two or more external flashes

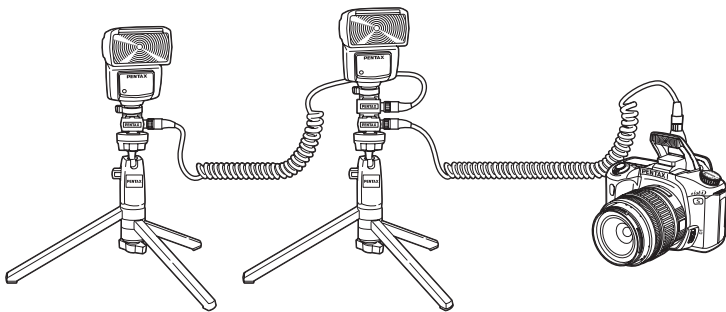

- The AF500FTZ can be connected directly to the Extension cord F5P without the off-camera shoe adapter F.
- When using multiple AF360FGZ units or an AF360FGZ unit with the built-in flash, P-TTL is used for flash control. Other flash combinations use TTL.

Contrast-Control-Synch Flash

Using AF330FTZ/AF500FTZ with AF360FGZ or AF360FGZ in combination with the built-in flash allows twin flash photography (contrast-control-synch flash photography). This is based on the difference between the amounts of light discharged from two units.



- Do not combine with accessories that have a different number of contacts such as a Hot Shoe Grip as a malfunction may occur.
- Combining with flashes from other manufacturers may cause equipment breakdown. We recommend using the PENTAX dedicated automatic flashes.

- 1 Connect the external flash to the camera indirectly. (p.157)
- 2 Set the sync mode for AF360FGZ to the Contrast-Control-Synch mode.
- 3 Turn the mode dial and set the exposure mode to **P**, **Tv**, **Av** or **M**.
- 4 Confirm that both the external flash and built-in flash are fully charged and then take the picture.



- For contrast control synch flash photography when using two external flashes, the flash set as the contrast control flash is flash 2, and the other external flash is flash 1. When using an external flash with the built-in flash, the built-in flash is flash 1, and the external flash is flash 2.
- When using two AF360FGZ units or an AF360FGZ unit with the built-in flash, P-TTL is used for flash control. Other flash combinations use TTL.
- The fastest flash synchronization speed is 1/90 second in the Contrast-Control-Synch mode.

Changing Playback Display Method

Set information to show during playback.

The camera switches display information when you press **INFO** button.

Images only	Only captured images are displayed.
Image+Histgrm	Images and histogram are displayed.
Image+Detailed Info	Image details appear with a small image in the upper left.
Last memory	Display settings are retained from previous session.

Set in [Plybk dsply mthd] in the [Playback] menu. (p.98)

5

Function Reference

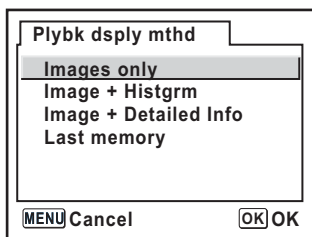

Refer to p.18 for various display information details.

Displaying Hot Spot Warning

If [Hot Spot wrnng] is selected on the Instant Review and playback screens, bright areas in the image blink.

The default setting is off.

OFF	Turn off the hot spot warning
Instant Review	Hot spot warning is displayed only during Instant Review.
Instnt review+Plybck	Hot spot warning is displayed during Instant Review and playback.

Set in [Hot spot wrng] in the [▶ Playback] menu. (p.98)

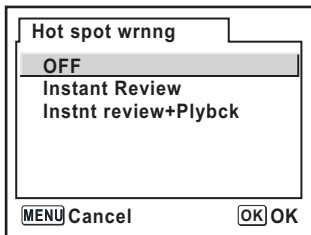

Setting the Slideshow Display Interval

You can play back all images recorded on your SD Memory Card successively. (p.68)

Set image display interval to [3 sec], [5 sec], [10 sec] or [30 sec]. The default setting is [3 sec].

Set in [Slideshow] in the [▶ Playback] menu (p.98).

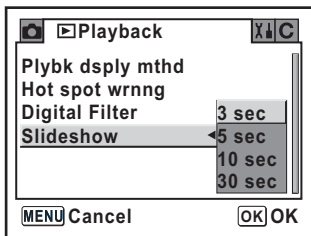

After setting, press the **OK** button to start slideshow.

Formatting the SD Memory Card

Be sure to format new SD Memory Card with the camera before using the card.

Formatting will delete all the data on the SD Memory Card.



- Do not open the card cover while formatting SD Memory Card. The card may be damaged beyond use.
- Formatting will delete protected data. Be aware.

1 Select [Format] on the [X↓ Set-up] menu (p.99).

2 Press the four-way controller (▶) to display the Format screen.

3 Use the four-way controller (▲) to select [Format].

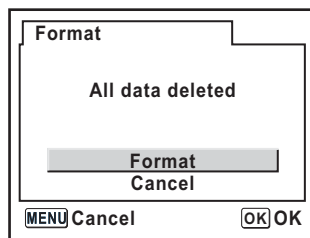

4 Press the OK button.

Formatting starts. When formatting is completed, the camera is ready to take pictures.

Turning the Beep On and Off

You can turn the camera operation beep on or off. The default setting is [On].

Set in [Beep] in the [X Set-up] menu. (p.99)

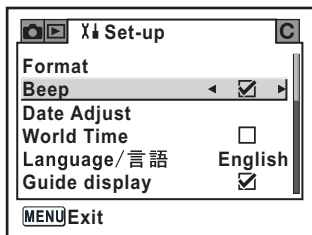

Changing the Date and Time and the Display Style

You can change the initial date and time settings. You can also set the display style. Choose [mm/dd/yy], [dd/mm/yy] or [yy/mm/dd]. Choose [12 hour] or [24 hour] for time display method.

☞ Setting the Date and Time (p.35)

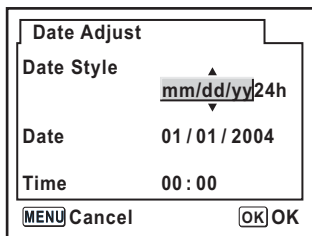

Setting the World Time

The date and time selected in [Initial Settings] (p.33) serve as the date and time of your present location.

Setting [World Time] enables you to display the local date and time on the LCD monitor when traveling overseas.

1 Select [World Time] on the [X] Set-up] menu. (p.99)

2 Press the four-way controller (▶).

The World Time screen appears.

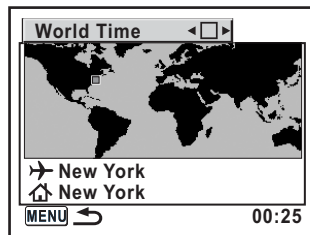

3 Use the four-way controller (◀▶) to select (On) or (Off).

<input checked="" type="checkbox"/>	Apply time of city set in → (Destination)
<input type="checkbox"/>	Apply time of city set in ↕ (Hometown)

4 Press the four-way controller (▼).

The selection frame moves to →. The city with → blinks.

5 Press the four-way controller (▶).

The screen for magnifying the Destination region appears.

Use the four-way controller (◀▶) to change the region to magnify.

6 Press the four-way controller (▼).

The frame moves to city.

7 Use the four-way controller (◀▶) to select the Destination city.

The current time, location and time difference of the selected city appears.

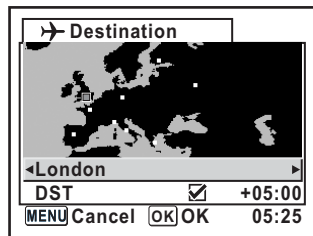

8 Use the four-way controller (▼) to select [DST].

9 Use the four-way controller (◀▶) to select (On) or (Off).

Select (On) if the Destination city uses daylight saving time (DST).

10 Press the OK button.

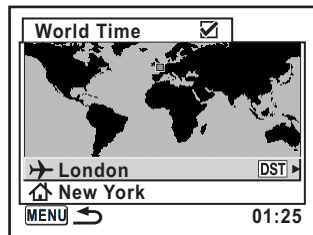

The World Time setting is saved.
To continue with World Time setting operations, press the **OK** button to return to the World Time screen.



11 Press the MENU button twice.

The camera is ready to take pictures.



- See “List of World Time Cities” (p.166) for cities that can be specified as a destination.
- Select  in Step 4 to set the city and DST setting.
-  appears on the guide display screen if World Time is on (). (p.16)

List of World Time Cities

Region	City	Region	City
North America	Honolulu	Africa/ West Asia	Nairobi
	Anchorage		Jeddah
	Vancouver		Tehran
	San Francisco		Dubai
	Los Angeles		Karachi
	Calgary		Kabul
	Denver		Male
	Chicago		Delhi
	Miami		Colombo
	Toronto		Kathmandu
	New York		Dacca
	Halifax		
Central and South America	Mexico City	East Asia	Yangon
	Lima		Bangkok
	Santiago		Kuala Lumpur
	Caracas		Vientiane
	Buenos Aires		Singapore
	Sao Paulo		Phnom Penh
	Rio de Janeiro		Ho chi Minh
			Jakarta
Europe	Madrid		Hong Kong
	London		Beijing
	Paris		Shanghai
	Milan		Manila
	Rome		Taipei
	Berlin		Seoul
	Athens		Tokyo
	Helsinki		Guam
	Moscow		
Africa/ West Asia	Dakar		Oceania
	Algiers	Adelaide	
	Johannesburg	Sydney	
	Istanbul	Noumea	
	Cairo	Wellington	
	Jerusalem	Auckland	
	Pago Pago		

Setting the Display Language

You can change the language in which the menus, error messages, etc. are displayed.

Set in [Language/言語] in the [\mathbb{X} Set-up] menu. (p.99)

☞ Setting the Display Language (p.33)



Turning the Guide Display On and Off

Set to display guides on the LCD monitor when main switch is on or Exposure mode is changed. (p.16)

<input checked="" type="checkbox"/>	Guide display on
<input type="checkbox"/>	Guide display off

Set in [Guide display] in the [\mathbb{X} Set-up] menu. (p.99)

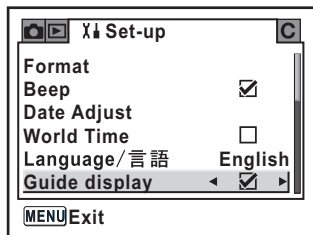

Adjusting the Brightness of the LCD Monitor

You can adjust the brightness of the LCD monitor. Adjust settings when the LCD monitor is hard to see.

Set in [Brightness Level] in the [**X** Set-up] menu. (p.99)

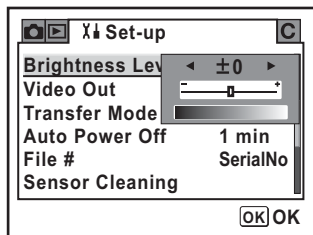

5

Function Reference

Selecting the Video Output Format

When you connect the camera to AV equipment such as a TV, choose the appropriate video output format (NTSC or PAL) for playing back images.

Set in [Video Out] in the [**X** Set-up] menu. (p.99)

☞ Connecting the Camera to AV Equipment (p.70)

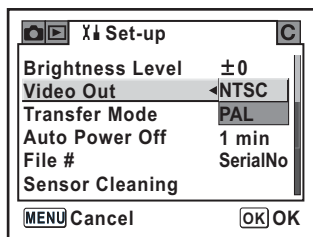

The video output format varies according to region. The video output format used in North America is NTSC.

Setting Auto Power Off

You can set the camera to turn off automatically if unused after a certain length of time. Select from [1 min], [3 min], [5 min], [10 min], [30 min] or [Off]. The default setting is [1 min].

Set in [Auto Power Off] in the [X Set-up] menu. (p.99)

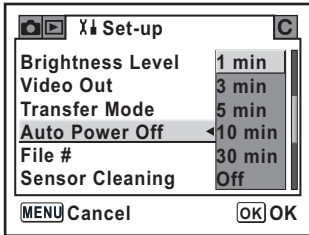

Auto Power Off will not work during slideshow playback, a USB connection, remote control shooting or while displaying menu or Fn menu.

5

Resetting the File Number

You can set the File Number used for the images when inserting a new SD Memory Card. The default setting is [SerialNo].

SerialNo	The file number for the most recently captured image is placed in memory and the file number will remain continuous after inserting the new SD Memory Card.
Reset	Every time a new SD Memory Card is inserted, the file number is the smallest number. When an SD Memory Card with stored images is inserted, numbering continues from the last stored file number.

Set in [File #] in the [X Set-up] menu. (p.99)

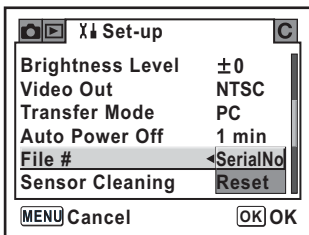

Setting the Instant Review

Setting the Display Time

Select from [1 sec], [3 sec], [5 sec] or [Off]. The default setting is [1 sec]. Set in [Instant Review] in the [📷 Rec. Mode] menu. (p.98)

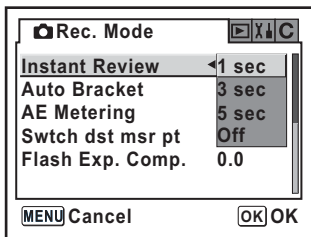

5

Displaying Histogram During Instant Review

Set to display histogram during Instant Review. Select [2 (Plybck with Hstgram)] in [Instant Review Dsply] in the [C Custom] menu. (p.101) The default setting is to not display histogram.

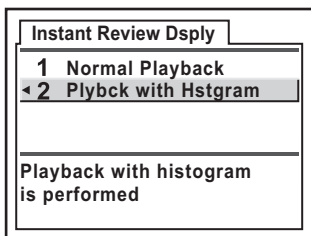

Resetting Rec. Mode/Playback/Set-up Menu

Settings in [📷 Rec. Mode] menu, [▶ Playback] menu and [X↓ Set-up] menu are reset to default settings.

However, Date Adjust, Language/言語, Video Out and World Time are not reset.

- 1** Select [Reset] on the [X↓ Set-up] menu.
- 2** Press the four-way controller (▶) to display the [Reset] screen.
- 3** Use the four-way controller (▲) to select [Reset].

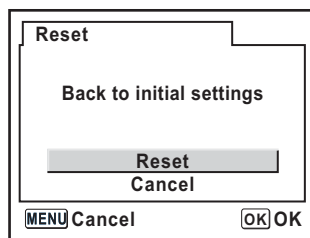

- 4** Press the **OK** button.

The camera is ready to take or play back images.

Resetting the Custom Function Menu

Reset settings in [C Custom] menu to default settings.

Settings in [Rec. Mode] menu, [Playback] menu and [Set-up] menu are not reset.

- 1 Select [Reset] on the [C Custom] menu.
- 2 Press the four-way controller (▶) and display the Reset Custom Fncn screen.
- 3 Use the four-way controller (▲) to select [Reset].

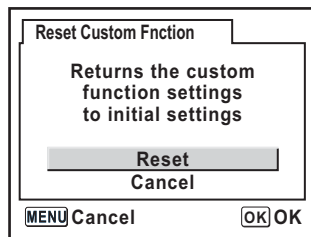

- 4 Press the OK button.

The camera is ready to take or play back images.

6 Appendix

Default Settings	174
Functions Available with Various Lens Combinations	177
Notes on [Using Aperture Ring]	179
Cleaning the CCD	180
Optional Accessories	182
Error Messages	185
Troubleshooting	187
Main Specifications	189
Glossary	192
Index	196
WARRANTY POLICY	200

The table below lists the factory default settings.
Table notations are as follows.

Last Memory Setting

Yes : The current setting (last memory) is saved when the camera is turned off.







No : The setting returns to the default setting when the camera is turned off.

Reset Setting

Yes : The setting returns to the default setting with the reset function (p.171).

No : The setting is saved even after reset.

[Rec. Mode] Menu

Item	Default Setting	Last Memory Setting	Reset Setting	Page
Image Tone	 (Bright)	Yes	Yes	p.108
Recorded Pixels	 (3008×2000)	Yes	Yes	p.109
Quality Level	★★★ (Best)	Yes	Yes	p.110
Saturation	 (0)	Yes	Yes	p.111
Sharpness	 (0)	Yes	Yes	p.111
Contrast	 (0)	Yes	Yes	p.111
Instant Review	1 sec	Yes	Yes	p.170
Auto Bracket	±0.5/0-+	Yes	Yes	p.145
AE Metering	 (Multi-segment)	Yes	Yes	p.130
Swthc dst msr pt	 (Auto)	Yes	Yes	p.123
Flash Exp. Comp.	0.0	Yes	Yes	p.146

[▶ Playback] Menu

Item	Default Setting	Last Memory Setting	Reset	Page
Plybk dsply mthd	Image only	Yes	Yes	p.160
Hot spot wrngng	Off	Yes	Yes	p.160
Digital Filter	B&W	Yes*	Yes	p.71
Slideshow	3 sec	Yes	Yes	p.68

* Only slimness for the slim filter is saved.

[X↓ Set-up] Menu

Item	Default Setting	Last Memory Setting	Reset	Page
Format	—	—	—	p.162
Beep	<input checked="" type="checkbox"/> (On)	Yes	Yes	p.163
Date Adjust	According to default setting	Yes	No	p.163
World Time	World Time setting	<input type="checkbox"/> (Off)	Yes	p.164
	Hometown (City)	According to default setting	Yes	
	Hometown (DST)	According to default setting	Yes	
	Destination (City)	Same as Hometown	Yes	
	Destination (DST)	Same as Hometown	Yes	
Language/言語	According to default setting	Yes	No	p.167
Guide display	<input checked="" type="checkbox"/> (On)	Yes	Yes	p.167
Brightness Level	0	Yes	Yes	p.168
Video Out	According to default setting	Yes	No	p.168
Transfer Mode	PC	Yes	Yes	p.84
Auto Power Off	1 min	Yes	Yes	p.169
File #	SerialNo	Yes	Yes	p.169
Sensor Cleaning	—	—	—	p.180
Reset	—	—	—	p.171

[C Custom] Menu

Item	Default Setting	Last Memory Setting	Reset	Page
Settings	□ (Off)	Yes	Yes	p.100
Noise Reduction	On	Yes	Yes	p.140
Exprs Setting Steps	1/2EV Steps	Yes	Yes	p.142
Sensvtvy Corction	Off	Yes	Yes	p.115
ISO Snstvty Wrn Dspl	Off	Yes	Yes	p.116
Link AF Point and AE	Off	Yes	Yes	p.131
Meter Operating Time	10 sec	Yes	Yes	p.132
AE-L with AF locked	Off	Yes	Yes	p.126
Recordable Image No.	Remaining image storage capacity	Yes	Yes	p.100
OK btn when shooting	Center of AF Point	Yes	Yes	p.120
Superimpose AF Area	On	Yes	Yes	p.123
AF in remote control	Off	Yes	Yes	p.100
FI with S lens used	Not available	Yes	Yes	p.101
Using aperture ring	Prohibited	Yes	Yes	p.179
Release when Chrging	Off	Yes	Yes	p.147
Instant Review Dsply	Normal Playback	Yes	Yes	p.170
Mag to Strt Zm Plybk	1.2 times	Yes	Yes	p.101
Man. WB Measurement	Entire screen	Yes	Yes	p.113
Color Space	sRGB	Yes	Yes	p.117
Reset Custom Fncion*	—	—	—	p.172

* Reset settings in [C Custom] menu.

Functions Available with Various Lens Combinations

Lenses that can be used with this camera

Only DA and FA J lenses and D FA/FA/F/A lenses having an **A** position on the aperture ring can be used with this camera. Refer to “Notes on [Using Aperture Ring]” (p.179) for other lenses and D FA/FA/F/A lenses with aperture ring set to a position other than **A**.

Function \ Lens [Mount type]	DA/D FA/ FA J/FA lens [KAF, KAF2] ^{*3}	F lens [KAF] ^{*3}	A lens [KA] ^{*3}
Autofocus (Lens only) (With AF adapter 1.7X) ^{*1}	Yes —	Yes —	No Yes
Manual focus (With the focus indicator) ^{*2} (With Matte field)	Yes Yes	Yes Yes	Yes Yes
Eleven focus points	Yes	Yes	No
Power zoom	No	No	No
Aperture Priority Auto Exposure	Yes	Yes	Yes
Shutter Priority Automatic Exposure	Yes	Yes	Yes
Manual Exposure	Yes	Yes	Yes
P-TTL Auto Flash ^{*4}	Yes	Yes	No
TTL Auto Flash	Yes	Yes	Yes ^{*5}
Multi (16-segment) metering	Yes	Yes	Yes

Yes : Functions are available when the aperture ring is set to the **A** position.

No : Functions are unavailable.

*1 Lenses with a maximum aperture of f/2.8 or brighter. Only available at **A** position.

*2 Lenses with a maximum aperture of f/5.6 or brighter.

*3 To use an F/FA soft 85 mm f/2.8 lens or FA soft 28 mm f/2.8 lens, set [Using aperture ring] to [2 (Permitted)] in the [**C** Custom] menu (p.100). Pictures can be taken with the aperture you set, but only within manual aperture range.

*4 When using the built-in flash and AF360FGZ.

*5 Built-in flash fully discharges when A lens is used.

Lens names and mount names

FA prime lenses (non-zoom lenses) and DA, D FA, FA J and F lenses use the KAF mount. Of the FA zoom lenses, power zoom enabled lenses use the KAF2 mount. Lenses without power zoom use the KAF mount. See the lens manual for details. This camera does not have a power zoom function.

Lenses and accessories that cannot be used with this camera

When aperture ring is set at other than **A** (Auto) or a lens without a **A** (Auto) position or accessories such as an auto extension tube or auto bellows are used, camera does not operate unless [Using aperture ring] is set to [2 (Permitted)] in the [**C** Custom] menu (p.101). Refer to Notes on [Using Aperture Ring] (p.179) for restriction that apply when [Using aperture ring] is set to [2 (Permitted)] in the [**C** Custom] menu.

All camera exposure modes are available when using DA/FA J or lenses with Aperture **A** (Auto) position set to that position.

Lens and Built-in Flash

The built-in flash cannot be regulated and fully fires when pre A lenses or soft lenses are used.

Note that the built-in flash cannot be used as the Auto Flash.

Aperture Ring Use

When [Using aperture ring] is set to [2 (Permitted)] in [**C** Custom] menu (p.101), the shutter can be released even if the aperture ring of the D FA, FA, F or A lens is not set to the **A** position or a lens without a **A** position is attached. However, the features will be restricted as shown in the table below.



The camera operates in **Av** (Aperture Priority) mode even if the mode dial is at **P** or **Tv** when the aperture is set to a value other than **A**.

Lens used	Capture mode	Restriction
D FA, FA, F, A, M (lens only or with auto diaphragm accessories such as auto extension tube K)	Av (Aperture Priority) mode	The aperture remains open regardless of the aperture ring position. The shutter speed changes in relation to the open aperture but an exposure error may occur. In the viewfinder, [F--] appears for the aperture indicator.
D FA, FA, F, A, M, S (with diaphragm accessories such as extension tube K)	Av (Aperture Priority) mode	Pictures can be taken with the specified aperture value but an exposure error may occur. In the viewfinder, [F--] appears for the aperture indicator.
Manual diaphragm lens such as reflex lens (lens only)	Av (Aperture Priority) mode	
FA, F Soft 85mm FA Soft 28mm (lens only)	Av (Aperture Priority) mode	Pictures can be taken with the specified aperture value in the manual aperture range. In the viewfinder, [F--] appears for the aperture indicator. When depth of field is checked (Preview), AE Metering is switched on. Exposure check is possible.
All lenses	M (Manual) mode	Pictures can be taken with the set aperture value and shutter speed. In the viewfinder, [F--] appears for the aperture indicator. When depth of field is checked (Preview), AE Metering is switched on. Exposure check is possible.

Cleaning the CCD

Shadows may appear in the image for white backgrounds and other shooting conditions if the CCD becomes dirty or dusty. This indicates that the CCD must be cleaned. Please contact PENTAX service center for professional cleaning because the CCD is a precision part.



- Do not use a spray type blower.
- Do not clean the CCD when the exposure mode is set to **B** (Bulb) mode.
- Always cap the lens mount area to prevent dirt and dust from accumulating on the CCD when no lens is on the camera.
- It is recommended to use the AC adapter when cleaning the CCD.
- When the battery level is low, “Not enough battery remaining to clean sensor” is displayed on the LCD monitor.
- If you are not using the AC adapter, please use batteries with ample capacity remaining. A warning beep will sound if the battery capacity becomes low during cleaning. Please stop cleaning immediately.
- Do not put the tip of the blower inside the lens mount area. If the power is turned off, this could cause damage to the shutter or the CCD sensor.



- Use of the AC adapter (optional) is recommended.
- The self-timer lamp blinks and [Cln] appears on the LCD panel while cleaning the CCD.

6

Appendix

- 1 Turn the camera off and remove the lens.**
- 2 Turn the camera on.**
- 3 Select [Sensor Cleaning] on the [X↓ Set-up] menu.**
- 4 Press the four-way controller (▶).**

The Sensor Cleaning screen appears.

-
- 5** Press the four-way controller (▲) to select [Mirror Up].

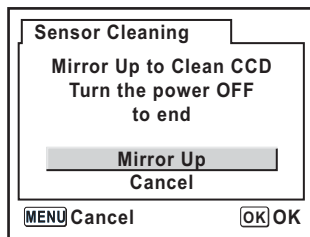

-
- 6** Press the OK button.

The mirror is locked in the up position.

-
- 7** Clean the CCD.

Use a brush-less blower to remove dirt and dust from the CCD. Using a blower with a brush may scratch the CCD. Do not wipe the CCD with a cloth.

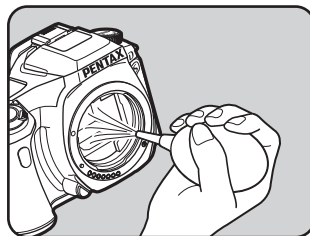

-
- 8** Turn the camera off.

-
- 9** Attach the lens after the mirror returns to its original position.

A number of dedicated accessories are available for this camera. Please contact a service center for details regarding accessories.

AC Adapter D-AC10

This AC adapter supplies power from the outlet into your camera.

Cable Switch CS-205

This is a remote shutter release cord. The cord length is 0.5 m.

Remote Control F

Shoot pictures from within 5 m of the front of the camera.

Flash Accessories

Auto Flash AF360FGZ

This is an auto flash unit with a maximum guide number of 36 (ISO 100/m). Its features include slave-sync flash, contrast-control-sync flash, AF spot beam, high-speed sync, wireless flash and front/rear curtain-sync.

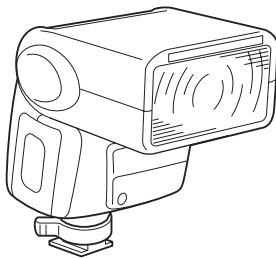

Off-camera Shoe Clip CL-10

This is a setting clip for using the AF360FGZ as a wireless slave flash.

Hot Shoe Adapter F₆**Extension Cord F5P****Off-camera Shoe Adapter F**

Use the adapters and cords to use the external flash away from the camera.

For Viewfinder

Magnifier FB

This viewfinder accessory is for magnifying the central area of the viewfinder.

Ref-converter A

This is an accessory that changes the viewfinder viewing angle at 90° intervals. The viewfinder magnification can be switched between 1× and 2×.

Diopter correction lens adapter M

This accessory adjusts the diopter. Install it on the viewfinder.

If it is difficult to see the viewfinder image clearly, choose one of the eight correction lenses M of -5 to $+3$ m^{-1} (per meter).

Interchangeable Focusing Screen

LF-60 : AF Framed Matte (standard)

LL-60 : AF Divided Matte

LI-60 : AF Scaled Matte

Camera Case

Camera Case O-CC28

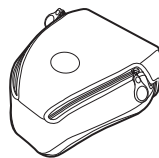

Others

The accessories below are the same as the accessories that are packaged with the camera.

Eyecup FL



Strap O-ST10

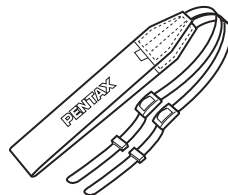

Error Message	Description
Memory card full	The SD Memory Card is full and no more images can be saved. Insert a new SD Memory Card or delete unwanted images. (p.29, p.73) You may be able to save new images by changing the quality level or recorded pixels. (p.109, p.110)
No image	There are no images for playback on the SD Memory Card.
Camera cannot display this image	You are trying to play back an image in a format not supported by this camera. You may be able to play it back on another brand of camera or your computer.
No card in camera	The SD Memory Card is not inserted in the camera. (p.29)
Memory card error	The SD Memory Card has a problem, and image capture and playback are impossible. Try displaying it on a PC.
Card not formatted	The SD Memory Card you have inserted is unformatted or has been formatted on a computer or other device and is not compatible with this camera. (p.29)
Card locked	A locked SD Memory Card is inserted in the camera. Unlock the SD Memory Card. (p.30)
Card is locked Rotation information cannot be saved	
This image is protected Rotation information cannot be saved	The selected rotated image is protected. Remove protection from the image. (p.77)
Cannot use this card	The inserted card cannot be used on a camera. Insert a usable card.
Battery depleted	The battery is exhausted. Install new batteries in the camera. (p.25)
Not enough battery remaining to clean sensor	Appears during CCD cleaning if battery level is insufficient. Replace the battery with a new one or use an AC adaptor (optional). (p.28)

Error Message	Description
Image folder could not be created	The maximum folder number (999) and file number (9999) are being used, and no more images can be saved. Insert a new SD Memory Card or format the card. (p.162)
Could not save image	The image could not be saved because of an SD Memory Card error.
Settings not stored	The DPOF settings file could not be saved because SD Memory Card is full. Delete unwanted images and set DPOF again. (p.73)
RAW images cannot be set	DPOF cannot be applied to the RAW images.
RAW images are not supported	RAW images cannot be processed using the digital filter.
This image cannot be filtered	If digital filter is started from [▶ Playback] menu, this message appears if all saved images are RAW files or images captured with other cameras.
No image to be filtered	Appears when digital filter is started from Fn menu for images captured with other cameras.
No DPOF files	No file set with DPOF. Set DPOF and print. (p.79)
Printer error	There is an error with the printer and the file cannot be printed. Fix error and print.
No paper in a printer	Printer has run out of paper. Put paper in printer and print.
No ink in a printer	Printer has run out of ink. Replace ink and print.
Paper stuck in a printer	Paper is jammed in printer. Remove paper and print.
Data error	A data error has occurred during printing.

We recommend checking the following items before contacting a service center.

Problem	Cause	Remedy
Camera does not turn on	Battery is not installed	Check if battery is installed. If not, install battery.
	Battery is not installed properly	Check orientation of battery. Re-insert battery according to the ⊕ ⊖ symbols. (p.25)
	Battery power is low	Replace with a charged battery or use the AC adapter. (p.28)
The shutter does not release	The lens aperture ring setting is other than the A position	Set the lens aperture ring to the A position (p.133) or select [2 (Permitted)] in [Using aperture ring] in the [C Custom] menu (p.179).
	Flash is charging	Wait until charging is finished.
	No available space on SD Memory Card	Insert SD Memory Card with available space or delete unwanted images. (p.29, p.73)
	Recording	Wait until recording is finished.
The Autofocus does not work	Subject is difficult to focus on	Autofocus cannot focus well on subjects that have low contrast (the sky, white walls), dark colors, intricate designs, are moving quickly or scenery shot through a window or a net-like pattern. Lock focus on another object located at same distance (press shutter release button halfway), then aim at target and press shutter release button fully. Alternatively, use manual focus. (p.121)
	Subject is not in focusing area	Position subject in focus frame in middle of viewfinder. If the subject is outside the focusing area, aim the camera at the subject and lock the focus (press shutter release button halfway), then compose picture and press the shutter release button fully.
	Subject is too close	Move away from the subject and take a picture.

Problem	Cause	Remedy
The Autofocus does not work	The focus mode is set to MF .	Set the focus mode lever to AF . (p.118)
AE lock function does not operate	AE lock is not available when set to M (manual) mode or B (bulb) mode	Set AE lock to setting other than M (manual) mode or B (bulb) mode.
Flash does not discharge	When flash mode is set to [Auto discharge] or [Auto flash+Redeye reduct], the flash will not discharge when the subject is bright.	Set flash mode to [Manual discharge] or [Manl flash+Redeye reduct]. (p.49)
	Mode dial is set to [Flash OFF]	Set mode dial to setting other than [Flash OFF]. (p.47)
The power zoom system does not function	The camera does not have the power zoom function.	Use manual zoom. (p.48)
USB connection with computer does not work properly	The transfer mode is set to [PictBridge].	Set transfer mode to [PC]. (p.84)
	An error occurred while sending USB data.	Change the transfer mode to [PC-F]. (p.84)
USB connection with printer does not work properly	The transfer mode is set to [PC] or [PC-F].	Set transfer mode to [PictBridge]. (p.84)

In rare cases, the camera may not operate correctly due to static electricity. This can be remedied by taking the batteries out and putting them back in again. When the mirror remains in the up position, take the batteries out and put them back in again. Then, turn the power on, and turn the power off while pressing the shutter release button. The mirror will retract. After the procedure is done, if the camera operates correctly, it does not require any repairs.



Type	TTL autofocus, auto-exposure SLR digital-still camera with built-in retractable P-TTL flash
Effective Pixels	6.10 megapixels
Sensor	Total pixels 6.31 megapixels, interline/interlace scan CCD with a primary color filter
Recorded Pixels	6M (RAW: 3008×2008/JPEG: 3008×2000 pixels), 4M (2400×1600 pixels), 1.5M (1536×1024 pixels)
Sensitivity	200/400/800/1600/3200: Standard Output Sensitivity
File Format	RAW, JPEG (Exif2.21), DCF compliant, DPOF compatible
Quality Level	RAW, ★★★ (Best), ★★ (Better), and ★ (Good)
Storage Medium	SD Memory Card
Number of Shots	

Size	Quality Level	Capacity			
		1GB	512MB	256MB	128MB
6M 3008×2008	RAW	Approx. 90	Approx. 46	Approx. 22	Approx. 11
6M 3008×2000	★★★	Approx. 330	Approx. 167	Approx. 78	Approx. 34
	★★	Approx. 607	Approx. 311	Approx. 149	Approx. 70
	★	Approx. 966	Approx. 498	Approx. 242	Approx. 117
4M 2400×1600	★★★	Approx. 459	Approx. 234	Approx. 111	Approx. 51
	★★	Approx. 807	Approx. 415	Approx. 201	Approx. 96
	★	Approx. 1397	Approx. 674	Approx. 330	Approx. 161
1.5M 1536×1029	★★★	Approx. 880	Approx. 453	Approx. 220	Approx. 106
	★★	Approx. 1397	Approx. 722	Approx. 354	Approx. 173
	★	Approx. 2151	Approx. 1115	Approx. 549	Approx. 271

Compression: ★★★ (Best) = 1/3, ★★ (Better) = 1/6, ★ (Good) = 1/12

LCD Monitor	2 inch low-temperature poly-silicon TFT color LCD with approx. 210000 pixels (with backlight)
Exposure mode	P Program, Tv Shutter priority, Av Aperture priority, M Manual, B Bulb Picture mode AUTO PICT Auto Picture, Normal, Portrait, Landscape, Macro, Moving Object, Night Scene Portrait, Flash OFF
Digital Filter	B&W, Sepia, Soft, Slim (only for processing after shooting)

Shutter	Electronically controlled vertical-run focal-plane shutter, Electromagnetic release, Speed range (1) Auto 1/4000-30 sec. (step less), (2) Manual 1/4000-30 sec. [1/2 EV step or 1/3 EV step] (3) Bulb, Shutter lock by setting Main switch in OFF position.
Lens Mount	Pentax KAF bayonet mount (K-mount with AF coupler, lens information contacts)
Lens used	Pentax KAF ₂ (not power zoom compatible), KAF mount lenses, KA mount lenses
Autofocus System	TTL phase-matching autofocus system (SAFOX VIII), AF operational brightness range: EV -1 to 18 (at ISO 100 with f/1.4 lens), Focus lock available, Focus Mode: AF/MF, adjustable focus point
Viewfinder	Penta-prism finder, Natural-Bright-Matte focusing screen, Field of view: 95%, Magnification 0.95× (with 50 mm f/1.4 lens at ∞), Diopter: -2.5m ⁻¹ to +1.5m ⁻¹ . (per meter)
Viewfinder Indication	Focus information: ● is lit when in-focus and blinking when unable to focus, ⚡ is lit=Built-in flash ready, Blinking=Flash should be used or incompatible lens is being used, Shutter speed, Aperture value, e-dial enabled indicator, Focus point, * =AE lock, Capacity remaining and ☒ =Exposure compensation
LCD Panel display	⚡ is lit=Built-in flash ready, Blinking=Flash should be used or incompatible lens is being used, ⚡AUTO =Auto discharge, ⚡AUTO ☉ =Redeye reduct Auto discharge, □ =Single frame shooting, ☒ =Cotinuous shooting, ☺ =Self-timer, 📡 =Remote control shooting, 🔋 =Battery exhaustion warning, 📷 =Auto bracketing exposure (exposure setting steps can be set to 1/2EV or 1/3EV), Shutter speed, Aperture value, White Balance, Capacity remaining and ☒ =Exposure compensation, PC (mass storage)/ Pb (PictBridge) appears when the USB cable is connected.
Depth of Field confirmation	Electronically controlled and usable in all exposure modes
Self-timer	Electronically controlled with delay time of 12 sec./2 sec. (with mirror lock up). Start by pressing shutter release button. Operation confirmation: Possible to set beep. Can be cancelled after operation
Mirror	Quick-return mirror, mirror lock up function (available at 2 sec. self-timer)
Auto Bracket	Three frames continuous shots with exposure bracketing (Selectable between 1/2EV and 1/3EV for Exposure setting steps)
Exposure Meter/ Metering Range	TTL multi (16)-segment metering, Metering range from EV1 to EV21.5 at ISO200, with 50 mm f/1.4 lens, Center-weighted and Spot metering mode can be set

EV Compensation	±2.0EV (Selectable between 1/2EV and 1/3EV for Exposure setting steps)	
AE lock	Button type (timer type 20 sec.) possible to continue with shutter button halfway pressed	
Built-in flash	P-TTL built-in flash with serial control , GN 15.6 (ISO 200/m), Angles of coverage: 20 mm lens angle of view, Flash synchronization speed range at 1/180 sec. and slower, Daylight-sync flash, Slow-speed-sync flash, ISO range = P-TTL: 200 to 3200	
External Flash sync	Hot shoe with X-contact, which couples with Pentax dedicated auto flashes, ISO range = P-TTL: 200-3200/TTL: 200-400, Automatic flash, Red-eye reduction flash function, High-speed-sync, wireless-sync with PENTAX dedicated flash.	
Custom Function	18 functions can be set	
Time Function	World Time settings for 68 cities (28 time zones)	
Power	Two CR-V3, four AA lithium, AA Ni-MH rechargeable, or AA alkaline batteries	
Battery Exhaustion	Battery exhaustion symbol  is lit. The shutter is locked and no indication appears in the viewfinder when  starts blinking	
In/Out Port	USB/Video terminal (USB2.0 (high speed compatible)), DC input terminal, Cable switch terminal	
Video Output Format	NTSC/PAL	
PictBridge	Compatible printer Print mode	PictBridge-compatible printer Print One, Print All, DPOF AUTOPRINT
Dimensions and Weight	125 mm (W) × 92.5 mm (H) × 66 mm (D) 505 g (body only without batteries)	
Accessories	Hot shoe cover F _K , Eyecup F _L , ME viewfinder cap, Body mount cover, USB Cable I-USB17, Video cable I-VC28, Software (CD-ROM) S-SW28, Strap O-ST10, Two CR-V3 lithium batteries, Operating manual (this book) and PENTAX PHOTO Browser 2.0/PENTAX PHOTO Laboratory 2.0 operating manual	

Specification for Remote Control (Optional)

Remote Control	Infrared Remote Control unit, captured about three seconds after remote control shutter button is pressed, operating distance = within approx. 5 m in front of the camera.
Power	One lithium battery (CR1620)
Size	22 mm (W) × 53 mm (H) × 6.5 mm (D)
Weight	7g (including battery)

AdobeRGB

Color space recommended by Adobe Systems, Inc. for commercial printing. Wider range of color reproduction than sRGB. Covers most of the color range so colors only available when printed are not lost when editing images from a computer. When image is opened by non-compatible software, the colors look lighter.

AE Metering

Brightness of subject is measured to determine exposure. In this camera, select from [Multi-segment Metering], [Center-weighted Metering] and [Spot Metering].

Aperture

The aperture increases or reduces the light beam (thickness) that passes through the lens.

6

Appendix

Auto Bracket

For automatically changing the shooting conditions. When the shutter button is pressed, three images are shot. The first one has no compensation, the second is under-exposed and the third is over-exposed.

Camera Shake (Blur)

When the camera moves while the shutter is open, the entire image appears as if flowing. This occurs more often when shutter speed is low. Prevent camera shake by raising the sensitivity, using the flash, and raising the shutter speed. Alternatively, use a tripod to stabilize the camera. Because camera motion causes camera shake, use the self-timer to prevent.

CCD (Charge Coupled Devices)

Photography element which converts the light entering through the lens into electric signals.

Color space

A defined range of colors from the spectrum which are used. In digital cameras, [sRGB] is defined as the standard by Exif. In this camera, [AdobeRGB] is also used because of the richer color expression over sRGB.

Color Temperature

This numerically expresses the color of the light source illuminating the subject. This is indicated in absolute temperature, using Kelvin (K) units. The color of light shifts to a bluish color as the color temperature rises, and to a reddish color as the color temperature falls.

DCF (Design Rule for Camera File System)

A digital camera file system standard established by the Japan Electronics and Information Technology Industries Association (JEITA).

Depth of Field

Area of focus. Reduce the aperture value to deepen.

DPOF (Digital Print Order Format)

Rules for writing information onto a card with recorded images regarding the specific images and number of copies to be printed. Prints can easily be made by taking images to a DPOF photo printing store.

EV (Exposure Value)

Exposure Value is determined by the combination of the aperture value and the shutter speed.

EV Compensation

Process of adjusting the image brightness by changing the shutter speed and aperture value.

Exif (Exchangeable image file format for digital still camera)

A standard digital camera file format established by the Japan Electronics and Information Technology Industries Association (JEIDA).

Focus points

Position in the viewfinder that determines focus. In this camera, select from [Auto], [Select] and [Center].

Histogram

A graph that shows the darkest and brightest points in an image. The horizontal axis represents the brightness and the vertical axis represents the number of pixels. This is useful when you wish to refer to the exposure status of an image.

Hot Spot

Hot spots in the image lose contrast and appear white.

JPEG

An image compression method. The image is recorded in JPEG format when the quality level is set to ★★★ (Best), ★★ (Better), or ★ (Good). Images recorded in JPEG format are suited for viewing on your PC or for attaching to e-mail.

Noise Reduction

Process to reduce noise (image roughness or unevenness) caused by low shutter speed.

NTSC/PAL

These are video output formats. NTSC is mainly used in Japan, North America, and South Korea. PAL is mainly used in Europe and in China.

Quality Level

This refers to the image compression ratio. The lower the compression, the more detailed the image. The image becomes rougher as the compression rate rises.

RAW data

Unedited image data output from the CCD. Raw data is data before being internally processed by the camera. Add settings that are added before shooting in other file formats (such as White Balance, Contrast, Color Tone and Sharpness) individually frame by frame after shooting. In addition, RAW data is 12bit data that contains 16 times the information of 8bit JPEG and TIFF data. Rich gradations are possible. Transfer RAW data to your computer and use the provided software to create image data with different settings, such as JPEG or TIFF.

Recorded Pixels

Indicates the size of the image by the number of pixels. The more pixels that compose a picture, the larger the image size.

Sensitivity

The degree of light. With a high sensitivity, images can be shot with a high shutter speed even in dark places, reducing camera shake. However, images with high sensitivity are more susceptible to noise.

Shutter Speed

The length of time that the shutter is open and light strikes the CCD. The amount of light that strikes the CCD can be changed by altering the shutter speed.

sRGB (standard RGB)

International standard of color space established by the IEC (International Electrotechnical Commission). This is defined from color space for PC monitors and is also used as the standard color space for Exif.

Vignetting

Vignetting occurs when portions of pictures are blackened because the subject was blocked by the hood or filter or the flash was blocked.

White Balance

While shooting, color temperature is adjusted to match the light source so that the subject appears to have correct color.

Symbols

[Rec. Mode] Menu	98, 174
[Playback] Menu	98, 175
[Set-up] Menu	99, 175
[C Custom] Menu	100, 176
Auto Picture	43, 47
Normal	47
Portrait	47
Landscape	47
Macro	47
Moving Object	47
Night Scene Portrait	47
Flash OFF	47
button	93, 95
button	94
button	93
button	95
button	93
Preview	129
A	
AC Adapter	28
Adding the Date	79
Adobe RGB	117
AE lock	142
AE Metering	130
AE-L button	93
AF360FGZ	153
Alkaline batteries	26
Aperture	128
Aperture Priority Mode Av	136
Auto Bracket	143
Auto Picture 	43, 47
Auto Power Off	169
AF (Autofocus)	118
Autofocus AF	118
AV Equipment	70

Av (Aperture Priority) mode	136
--	-----

B







B&W (Digital Filter)	71
Batteries	25
Beep	163
Bright	108
Brightness of the LCD Monitor	168
Built-in flash	49, 146
B (Bulb) Mode	140
Bulb Mode B	140

C

Cable Switch	140
Capture Information	17, 18
Card access lamp	15
CCD Cleaning	180
Center-weighted	131
Cloudy (White Balance)	112
Color space	117
Color Temperature	113
Continuous Autofocus	126
Continuous Shooting	53
Contrast	111
Contrast-Control-Sync Flash	159
CR-V3	26
Custom Function	100
[C Custom] Menu	100, 176



D

Date Adjust	35
Date change	163
Daylight (White Balance)	112
Daylight-Sync Shooting	52
Default Setting	33, 174

- Delete 73
 - Delete All Images 74
 -  (Delete) button 94
 - Deleting a Single Image 73
 - Depth of Field 128
 - Digital Filter 71
 - Diopter Adjust 39
 - Direct Printing 83
 - Display Language 167
 - Display Style 160
 - DPOF AUTOPRINT 90
 - DPOF Settings 79
 - Drive Mode 102
- E**
- e-dial 93
 - Error Message 185
 - EV Compensation 141
 -  **Av** (EV Compensation/Av) button 93
 - Exposure 127
 - Exposure metering timer 144
 - Exposure Mode 132
 - Exposure Warning 135, 137, 139
 - External flash 153
- F**
- File # 169
 - Filter 71
 - Fireworks 140
 - Fix Exposure 126
 - Fix Focus 125
 - Flash 49, 146
 - Flash (White Balance) 112
 - Flash Compensation 146
 - Flash Off 47
 - Flash OFF  47
 -  **UP** (Flash pop-up) button 93
 - Fluorescent Light (White Balance) 112
 - Fn** button 93, 95
- Fn** Menu 102
 - Focus Indication 101
 - Focus Lock 125
 - Focus mode lever 93
 - Focus Point 123
 - Focusing 118
 - Format 162
 - Four-way controller 93, 95
- G**
- Guide display 16, 167
- H**
- High-Speed Flash Sync Mode 155
 - Histogram 19, 170
 - Hot Spot Warning 160
- I**
- Image Tone 108
 - INFO** button 93, 95
 - Instant Review 170
 - ISO Sensitivity 115
 - ISO Sensitivity Warning Display 116
- L**
- Landscape  47
 - Language 33
 - Last Memory 174
 - LCD Monitor 16
 - LCD panel 22
 - Lens 37, 177
 - Lens unlock button 38, 92
 - Lithium batteries 26
- M**
- Macro  47
 - Main switch 92, 94
 - MF** (Manual focus) 121
 - Manual focus **MF** 121

Manual White Balance	113
Matte Field	122
MENU button	93, 94
Menu Operation	96
Meter Operating Time	132
Mirror Lock Up	62, 181
Mode dial	93, 104
Moving Object 	47
Multiple Flashes	158
Multi-segment	130



N



Natural	108
Night Scene	140
Night Scene Portrait 	47
Ni-MH	26
Ni-MH rechargeable battery ...	26
Nine-Image Display	66
Noise Reduction	140
Normal 	47
NTSC	168

O

OK button	93, 95
Optional Accessories	182

P

P (Program) Mode	133
PAL	168
Panel Indicators	16
PC-F	188
PictBridge	83
Pixels	109
Playback	18, 63
 (Playback) button	93, 95
 Playback] Menu	98, 175
Playback Time	27
Portrait 	47
Power	32
Press fully	45
Press halfway	45

Preview 	129
Print All	88
Print One	86
Print Service	79
Printer connection	85
Program Mode P	133
Protect	77
 (Protect) button	95
P-TTL (Auto)	154
P-TTL (Flash)	156

Q

Quality Level	31, 110
---------------------	---------

R

RAW	110
Rear Curtain Sync Flash	157
[ Rec. Mode] Menu ...	98, 174
Recorded Pixels	31, 109
Red-eye reduction	52, 157
Remaining image storage capacity	27
Remote Control	59
Reset	171, 172
Rotate	64

S

Saturation	111
SD Memory Card	29
Select&Delete	75
Self-Timer	55
Sensitivity	115
Sensitivity Correction	115
Sepia (Digital Filter)	71
[ Set-up] Menu	99, 175
Shade (White Balance)	112
Sharpness	111
Shutter Priority Mode Tv	134
Shutter release button	45, 92, 94
Shutter speed	127

Slideshow	68, 161
Slim (Digital Filter)	71
Soft (Digital Filter)	71
Spot Metering	131
sRGB	117
Strap	24
Superimpose AF Area	124

T

Transfer Mode	84
Tungsten Light (White Balance)	112
Turning	167
TV	70
Tv (Shutter Priority) mode	134

U

USB cable	83
Using aperture ring	179

V

Video cable	70
Video Output Format	168
Viewfinder	20, 39
Vignetting	195

W

White Balance	112
Wireless Mode	155
World Time	164

Z

Zoom Display	65
Zoom Lens	48

All PENTAX cameras purchased through authorized bona fide photographic distribution channels are guaranteed against defects of material or workmanship for a period of twelve months from date of purchase. Service will be rendered, and defective parts will be replaced without cost to you within that period, provided the equipment does not show evidence of impact, sand or liquid damage, mishandling, tampering, battery or chemical corrosion, operation contrary to operating instructions, or modification by an unauthorized repair shop. The manufacturer or its authorized representatives shall not be liable for any repair or alterations except those made with its written consent and shall not be liable for damages from delay or loss of use or from other indirect or consequential damages of any kind, whether caused by defective material or workmanship or otherwise; and it is expressly agreed that the liability of the manufacturer or its representatives under all guarantees or warranties, whether expressed or implied, is strictly limited to the replacement of parts as hereinbefore provided. No refunds will be made on repairs by nonauthorized PENTAX service facilities.

6

Appendix

Procedure During 12-month Warranty Period

Any PENTAX which proves defective during the 12-month warranty period should be returned to the dealer from whom you purchased the equipment or to the manufacturer. If there are no representatives of the manufacturer in your country, send the equipment to the manufacturer, with postage prepaid. In this case, it will take a considerable length of time before the equipment can be returned to you owing to the complicated customs procedures required. If the equipment is covered by warranty, repairs will be made and parts replaced free of charge, and the equipment will be returned to you upon completion of servicing. If the equipment is not covered by warranty, regular charges of the manufacturer or of its representatives will apply. Shipping charges are to be borne by the owner. If your PENTAX was purchased outside of the country where you wish to have it serviced during the warranty period, regular handling and servicing fees may be charged by the manufacturer's representatives in that country. Notwithstanding this, your PENTAX returned to the manufacturer will be serviced free of charge according to this procedure and warranty policy. In any case, however, shipping charges and customs clearance fees to be borne by the sender. To prove the date of your purchase when

required, please keep the receipt or bills covering the purchase of your equipment for at least a year. Before sending your equipment for servicing, please make sure that you are sending it to the manufacturer's authorized representatives or their approved repair shops, unless you are sending it directly to the manufacturer. Always obtain a quotation for the service charge, and only after you accept the quoted service charge, instruct the service station to proceed with the servicing.

- **This warranty policy does not affect the customer's statutory rights.**
- **The local warranty policies available from PENTAX distributors in some countries can supersede this warranty policy. Therefore, we recommend that you review the warranty card supplied with your product at the time of purchase, or contact the PENTAX distributor in your country for more information and to receive a copy of the warranty policy.**



The CE Mark is a Directive conformity mark of the European Community.

For customers in USA

STATEMENT OF FCC COMPLIANCE

This device complies with Part 15 of the FCC Rules. Operation is subject to the following two conditions: (1) This device may not cause harmful interference, and (2) this device must accept any interference received, including interference that may cause undesired operation.

Changes or modifications not approved by the party responsible for compliance could void the user's authority to operate the equipment.

This equipment has been tested and found to comply with the limits for a Class B digital device, pursuant to part 15 of the FCC Rules.

These limits are designed to provide reasonable protection against harmful interference in a residential installation. This equipment generates, uses and can radiate frequency energy and, if not installed and used in accordance with the instructions, may cause harmful interference to radio communications. However, there is no guarantee that interference will not occur in a particular installation.

If this equipment does cause harmful interference to radio or television reception, which can be determined by turning the equipment off and on, the user is encouraged to try to correct the interference by one or more of the following measures:

- Reorient or relocate the receiving antenna.
- Increase the separation between the equipment and receiver.
- Connect the equipment into an outlet on a circuit different from that to which the receiver is connected.
- * Consult the dealer or an experienced radio/TV technician for help.

For customers in Canada

This Class B digital apparatus meets all requirements of the Canadian Interference - Causing Equipment Regulations.

Pour les utilisateurs au Canada

Cet appareil numérique de la classe B respecte toutes les exigences du Règlement sur le matériel brouilleur du Canada.

Memo

Memo

Declaration of Conformity
According to 47CFR, Parts 2 and 15 for
Class B Personal Computers and Peripherals

We: PENTAX Imaging Company
A Division of PENTAX of America, Inc.

Located at: 600 12th Street, Suite 300
Golden, Colorado 80401 U.S.A.
Phone: 303-799-8000 FAX: 303-790-1131

Declare under sole responsibility that the product identified herein complies with 47CFR Parts 2 and 15 of the FCC rules as a Class B digital device. Each product marketed is identical to the representative unit tested and found to be compliant with the standards. Records maintained continue to reflect the equipment being produced can be expected to be within the variation accepted, due to quantity production and testing on the statistical basis as required by 47CFR §2.909. Operation is subject to the following two conditions: (1) This device may not cause harmful interference, and (2) This device must accept any interference received, including interference that may cause undesired operation. The above named party is responsible for ensuring that the equipment complies with the standards of 47CFR §15.101 to §15.109.

Product Name: PENTAX Digital Still Camera

Model Number: **istDS*

Contact person: Customer Service Manager

Date and Place: October, 2004, Colorado

- PENTAX Corporation** 2-36-9, Maeno-cho, Itabashi-ku, Tokyo 174-8639, JAPAN
(<http://www.pentax.co.jp/>)
- PENTAX Europe GmbH
(European Headquarters)** Julius-Vosseler-Strasse, 104, 22527 Hamburg,
GERMANY
(HQ - <http://www.pentaxeurope.com>)
(Germany - <http://www.pentax.de>)
- PENTAX U.K. Limited** PENTAX House, Heron Drive, Langley, Slough, Berks
SL3 8PN, U.K.
(<http://www.pentax.co.uk>)
- PENTAX France S.A.S.** 12/14, rue Jean Poulmarch, 95106 Argenteuil Cedex,
FRANCE
- PENTAX Benelux B.V.** (for Netherlands)
Spinveld 25, 4815 HR Breda, NETHERLANDS
(<http://www.pentax.nl>)
(for Belgium & Luxembourg)
Weiveldlaan 3-5, 1930 Zaventem, BELGIUM
(<http://www.pentax.be>)
- PENTAX (Schweiz) AG** Widenholzstrasse 1 Postfach 367 8305 Dietlikon,
SWITZERLAND
(<http://www.pentax.ch>)
- PENTAX Scandinavia AB** P.O. Box 650, 75127 Uppsala, SWEDEN
(<http://www.pentax.se>)
- PENTAX Imaging Company**
A Division of PENTAX of America, Inc.
(Headquarters)
600 12th Street, Suite 300 Golden, Colorado 80401, U.S.A.
(Distribution & Service Center)
16163 West 45th Drive, Unit H Golden, Colorado 80403,
U.S.A. (<http://www.pentaximaging.com>)
- PENTAX Canada Inc.** 1770 Argentia Road Mississauga, Ontario L5N 3S7,
CANADA
(<http://www.pentaxcanada.ca>)



<http://www.digital.pentax.co.jp>

- Specifications and external dimensions are subject to change without notice.